

LARGA

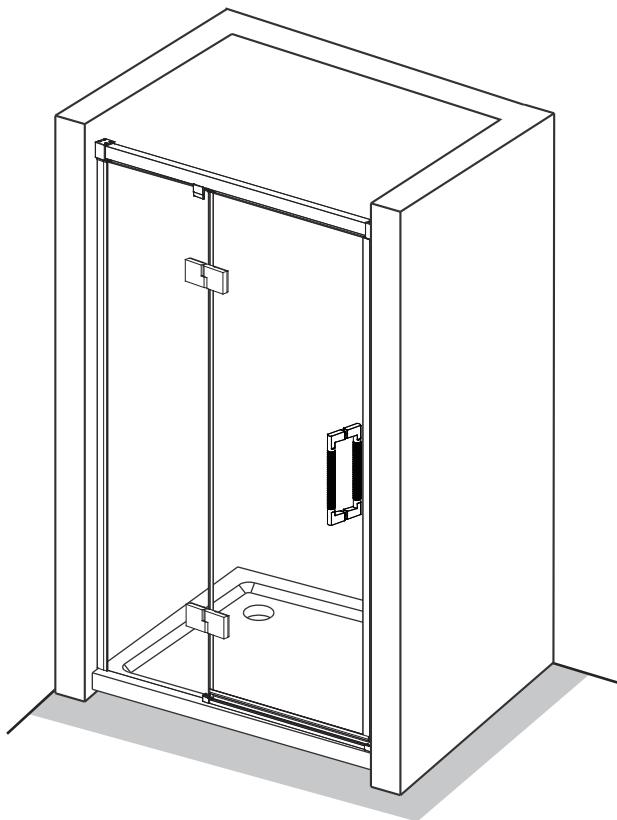

PL INSTRUKCJA MONTAŻU I EKSPLOATACJI

CZ NÁVOD NA MONTÁŽ A ÚDRŽBU

SK NÁVOD NA MONTÁŽ A ÚDRŽBU

EST PAIGALDUS- JA KASUTUSJUHEND

LT MONTAVIMO IR EKSPLOAVIMO INSTRUKCIJA

LV MONTĀŽAS UN EKSPLUATĀCIJAS INSTRUKCIJA

DE MONTAGE- UND AUFBAUANLEITUNG

RO INSTRUCȚIUNI DE MONTAJ ȘI OPERARE

HU SZERELÉSI ÉS ÜZEMELTETÉSI ÚTMUTATÓ

UA ІНСТРУКЦІЯ З МОНТАЖУ І ЕКСПЛУАТАЦІЇ

BY ІНСТРУКЦЫЯ ПА МАНТАЖЫ І ЭКСПЛУАТАЦЫІ

RU ИНСТРУКЦИЯ ПО МОНТАЖУ И ЭКСПЛУАТАЦИИ

EN INSTRUCTIONS FOR ASSEMBLY AND USE

FR INSTALLATION ET UTILISATION - MODE

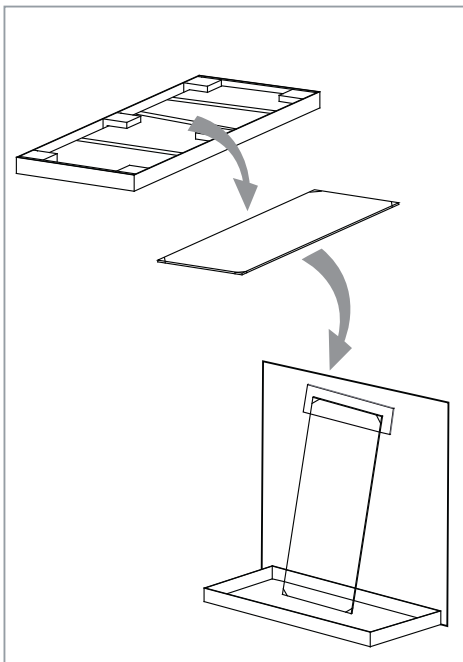
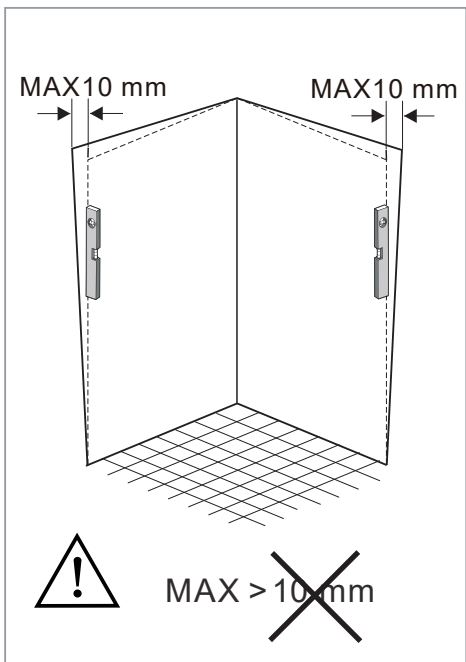
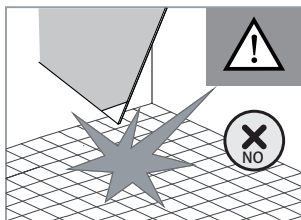
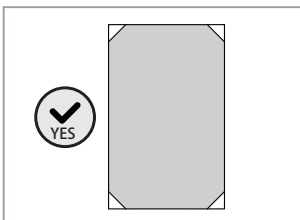
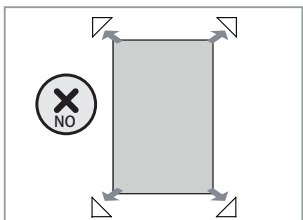
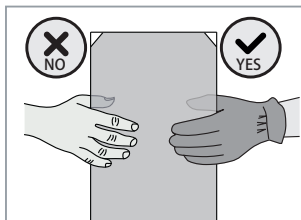
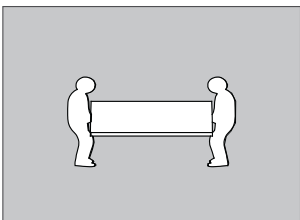
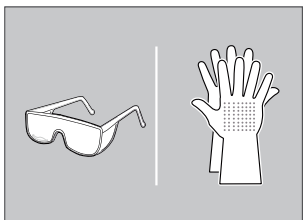
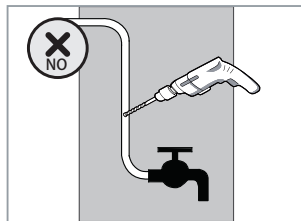
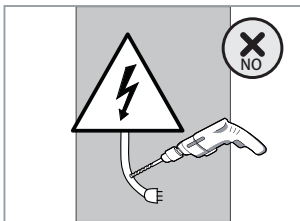
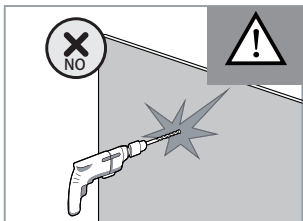

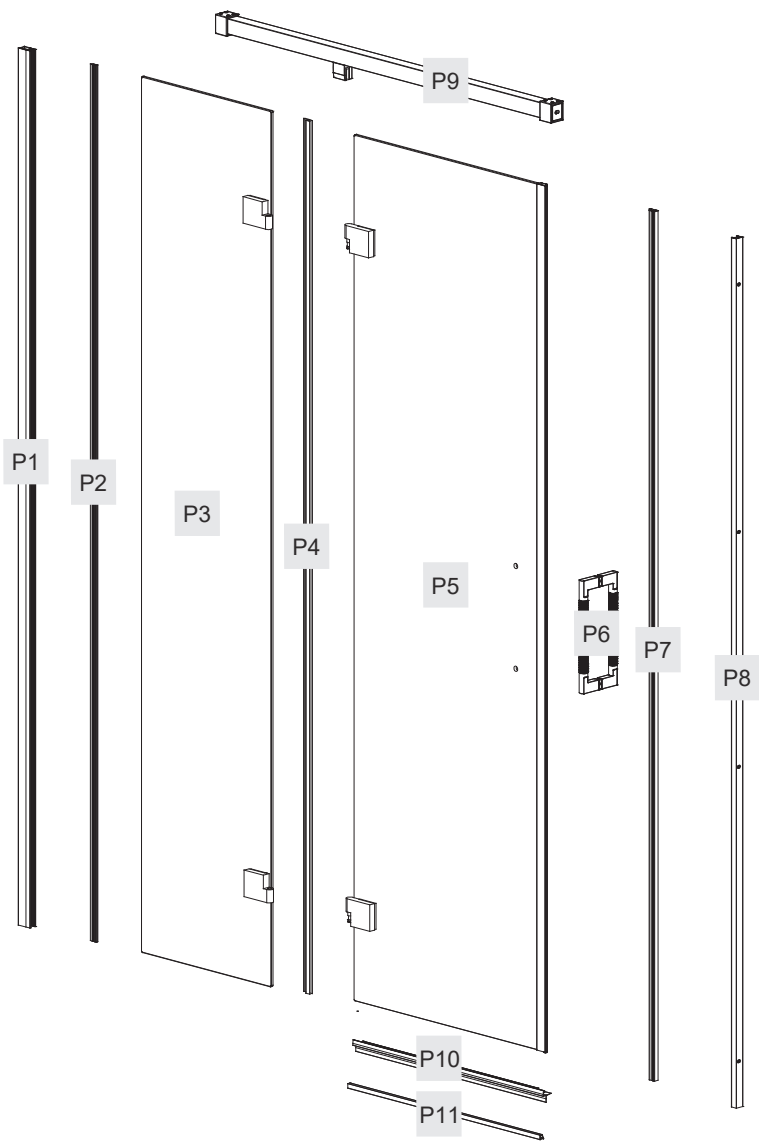

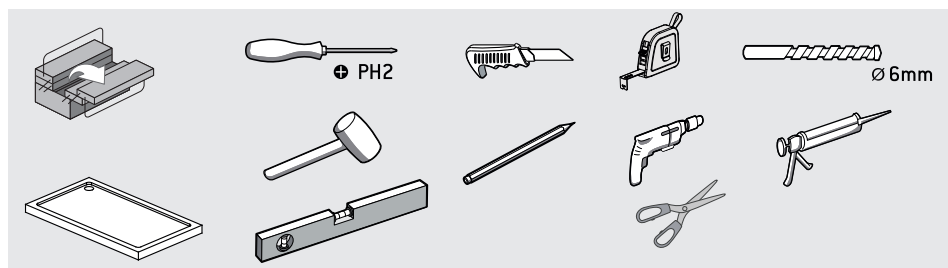
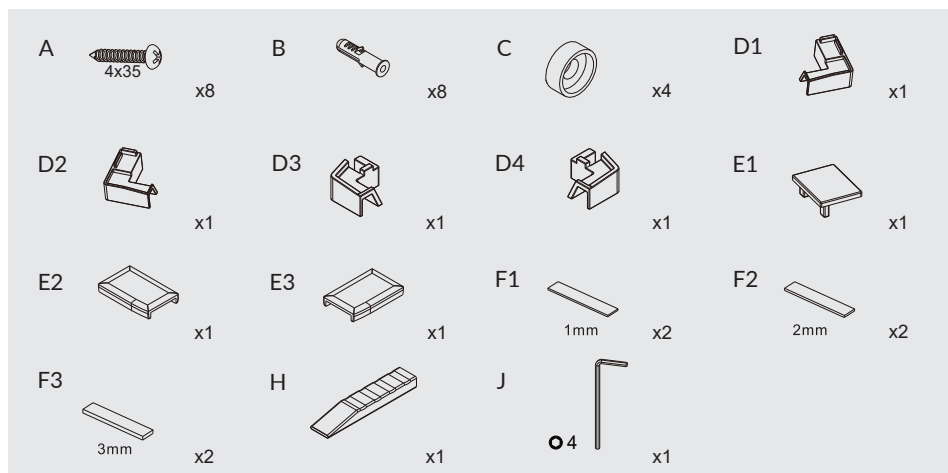
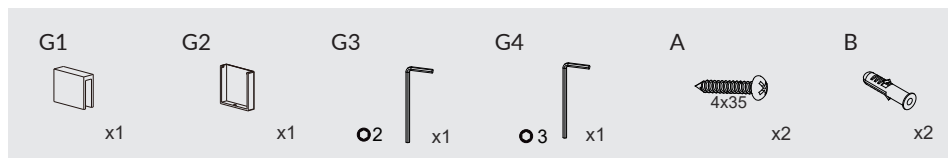
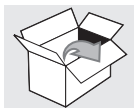

1.

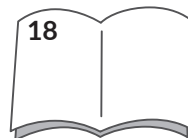
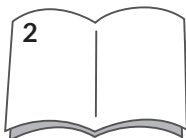
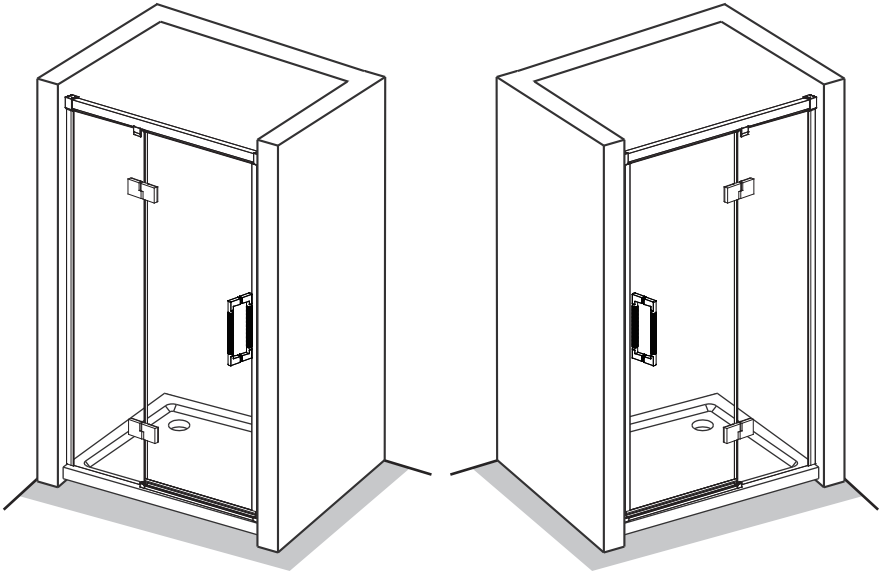

2.

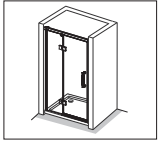

SIZE	X(mm)
800 × 2000	790-800
900 × 2000	890-900
1000 × 2000	990-1000
1200 × 2000	1190-1200

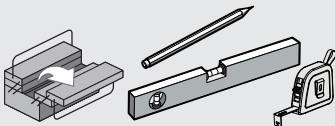
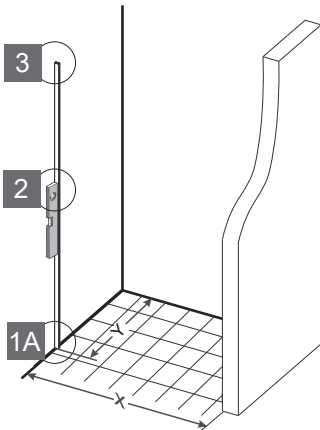
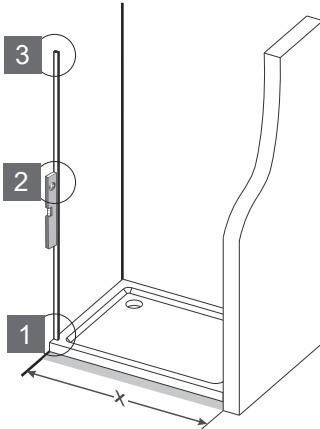
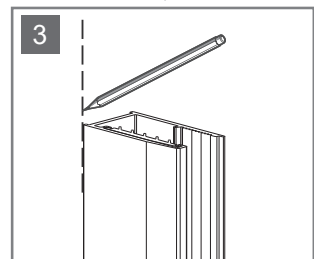
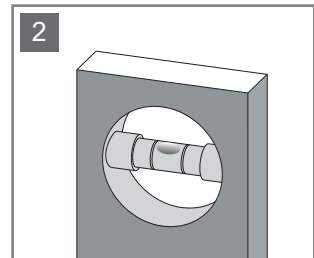
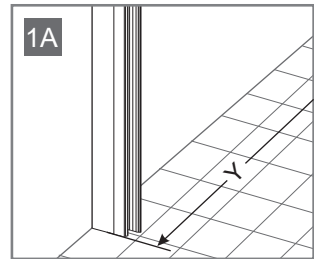
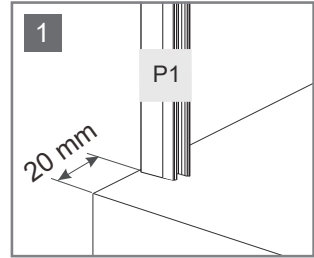

P1  x1



3.

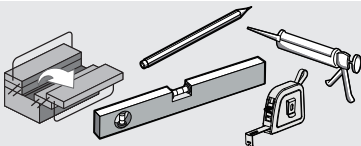
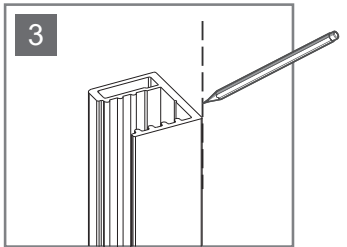
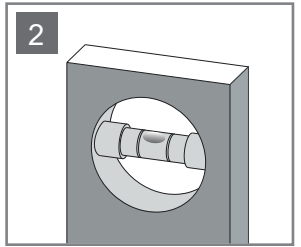
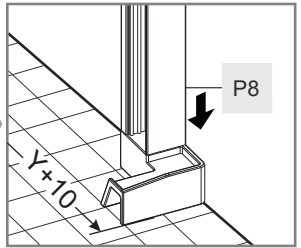
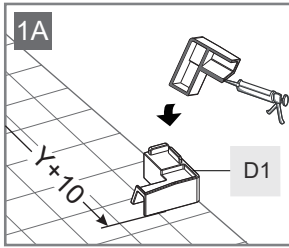
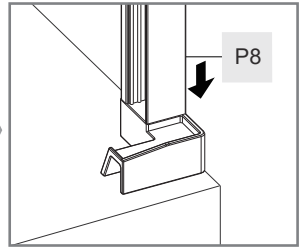
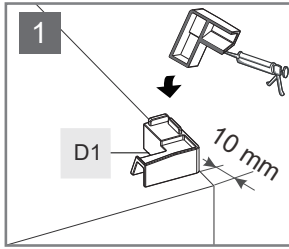
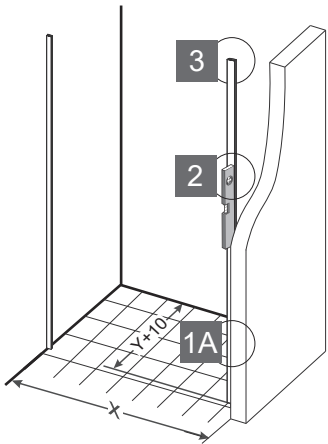
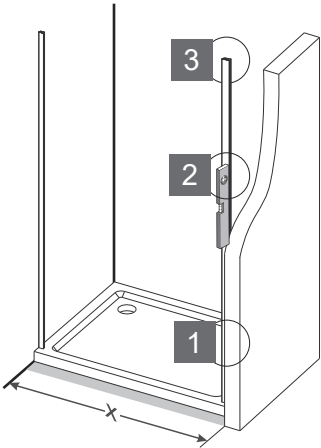
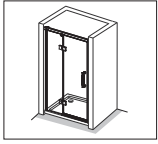

D1  x1

P8  x1



4.

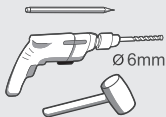
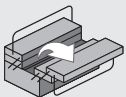
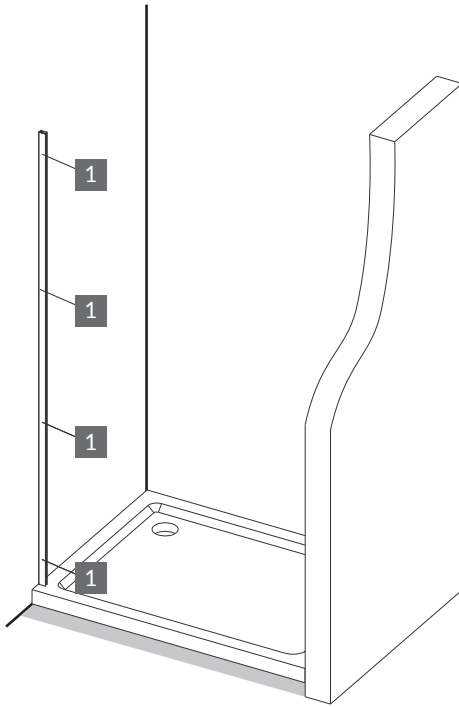
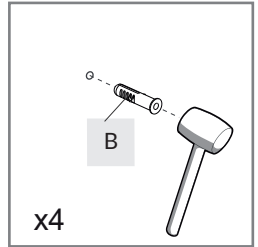
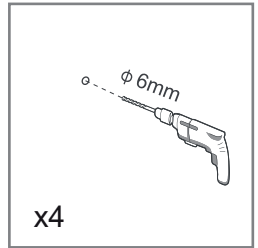
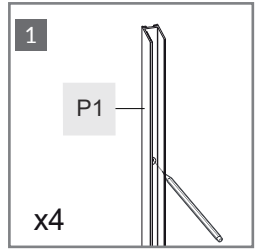
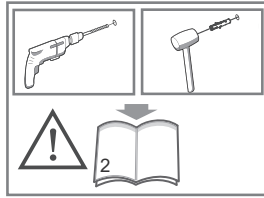
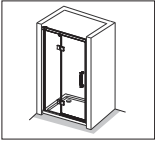

B



x4



5.

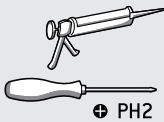
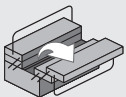
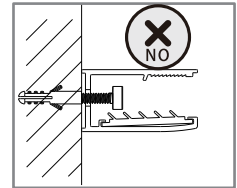
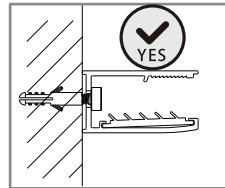
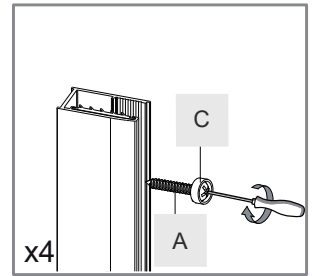
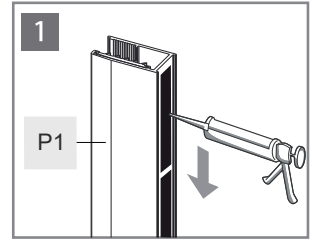
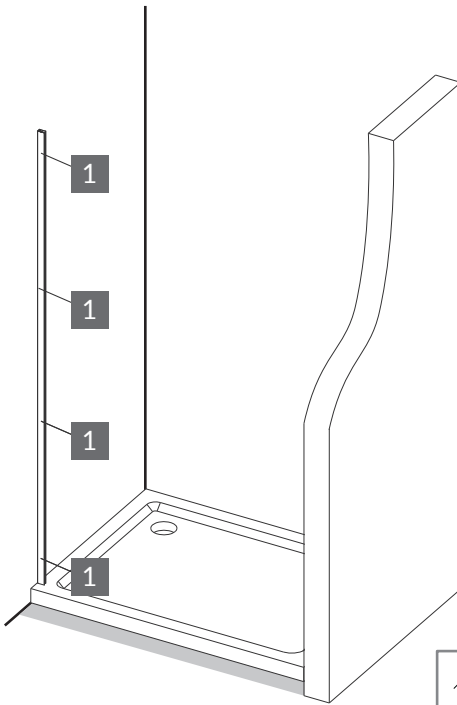
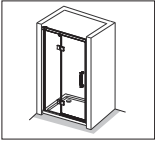

A



x4

C



x4



6.

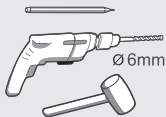
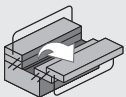
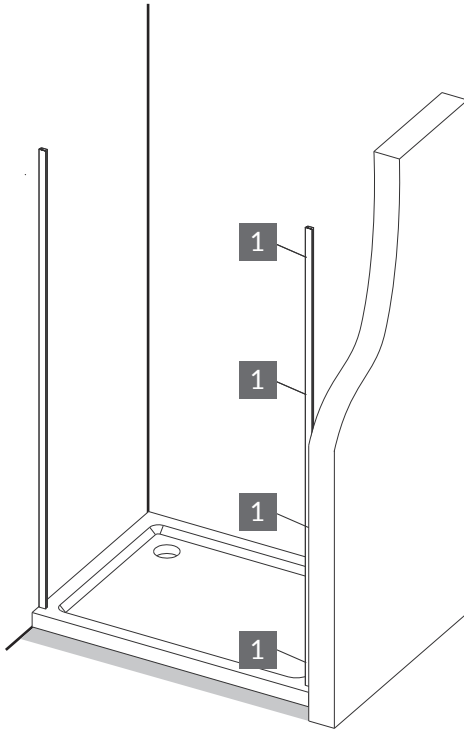
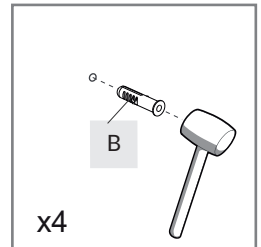
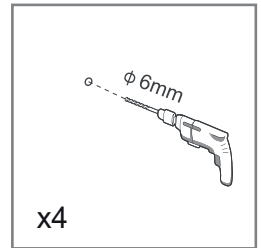
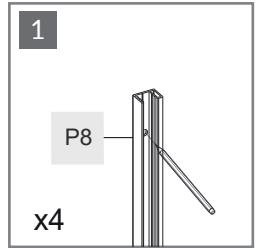
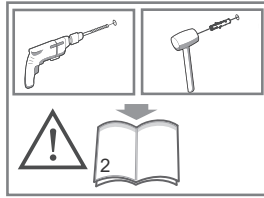
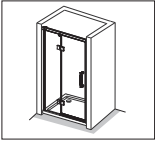

B



x4



7.

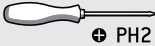
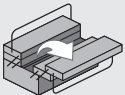
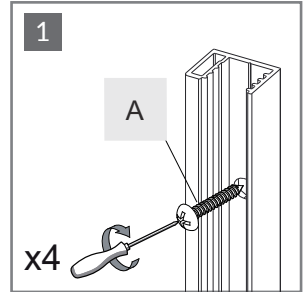
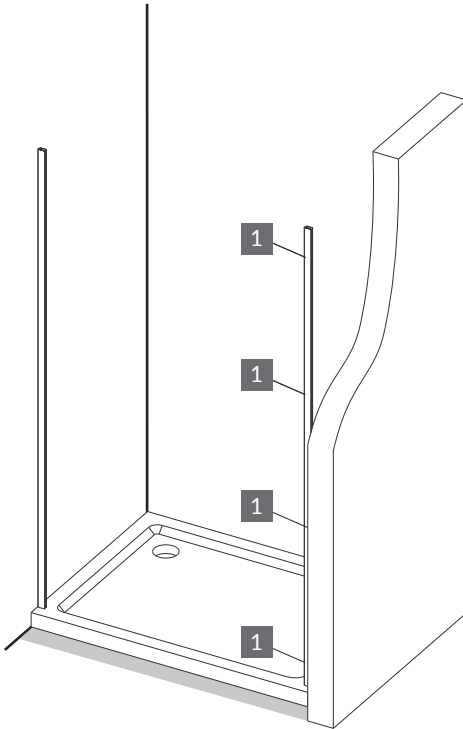
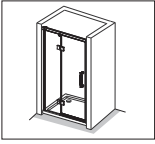

PH2

A



4x35

x4



8.

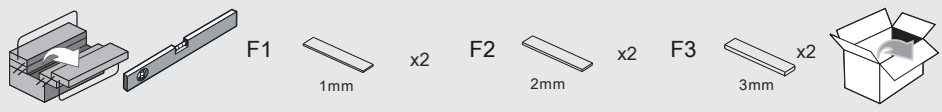
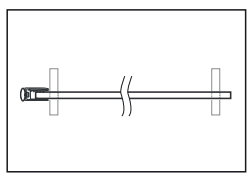
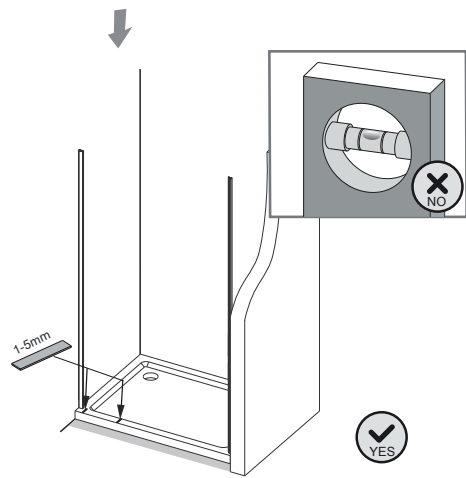
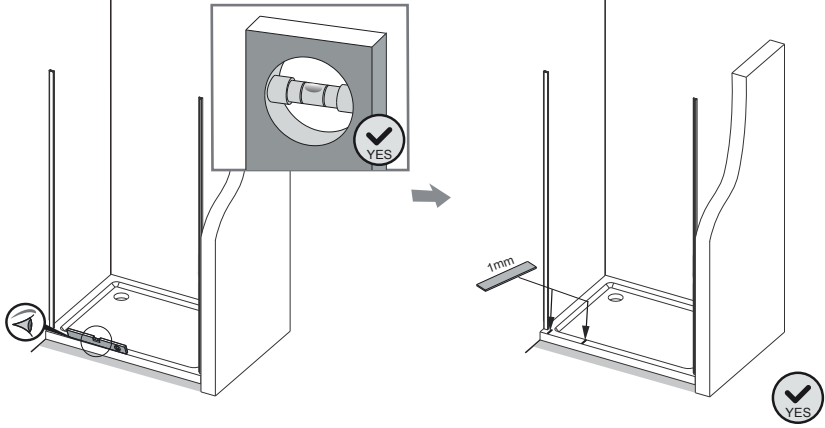
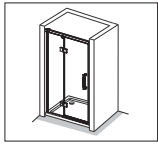

9.

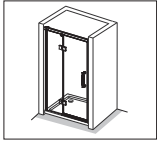

SIZE	X(mm)
800 × 2000	426
900 × 2000	526
1000 × 2000	626
1200 × 2000	726

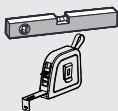
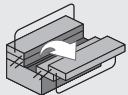
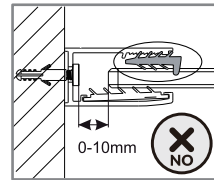
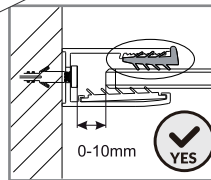
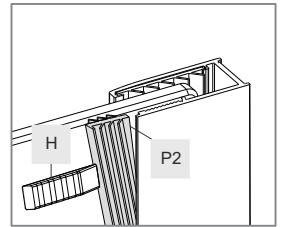
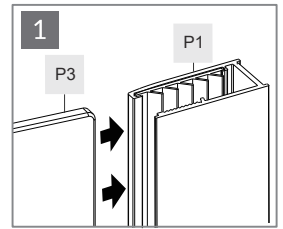
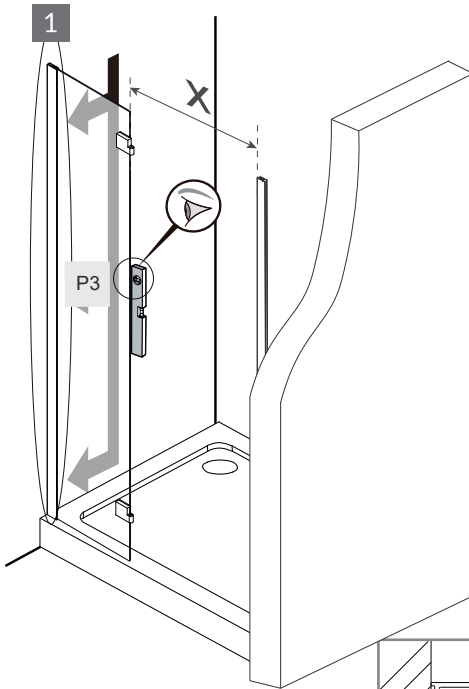
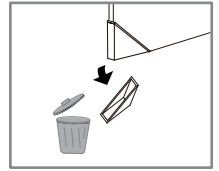
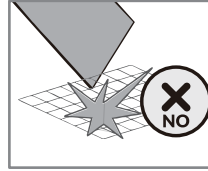

P2 ————— x1

H ————— x1

P3 ————— x1



10.

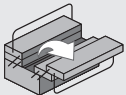
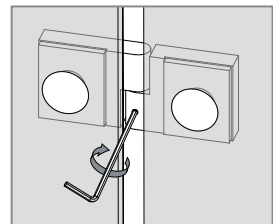
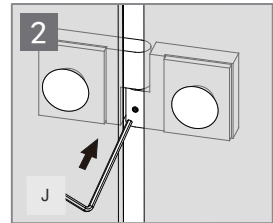
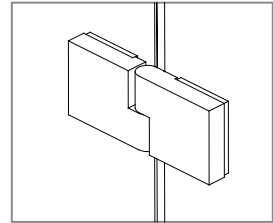
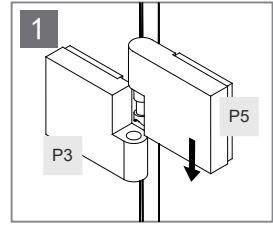
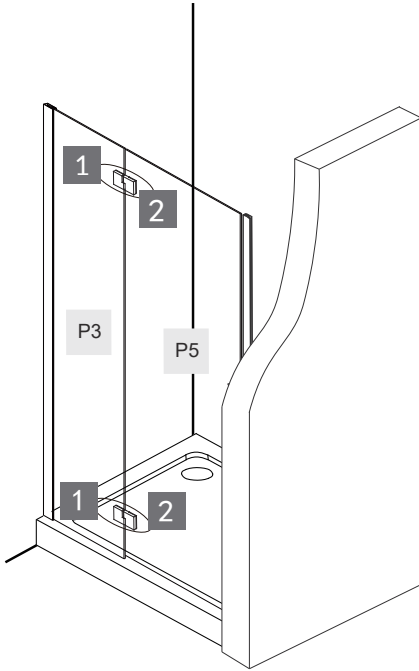
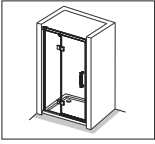

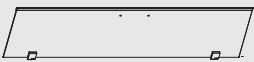
P5  x1

J  x1



11.

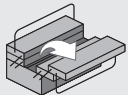
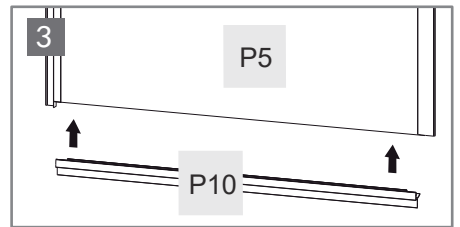
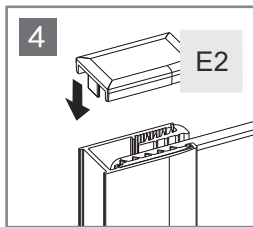
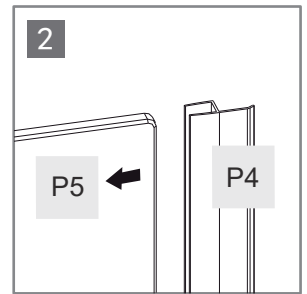
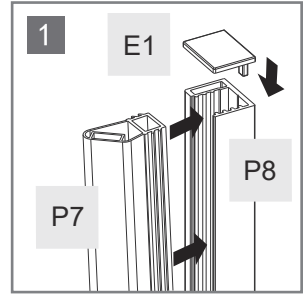
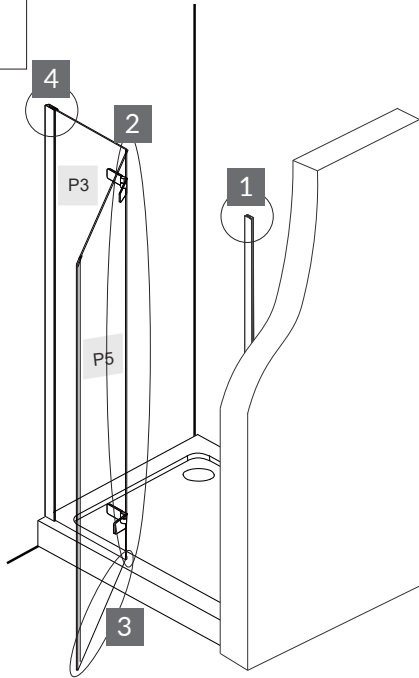
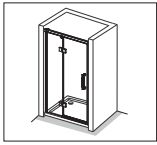

- | | | | | | |
|-----|--|----|----|--|----|
| P7 | | x1 | E1 | | x1 |
| P4 | | x1 | E2 | | x1 |
| P10 | | x1 | | | |



12.

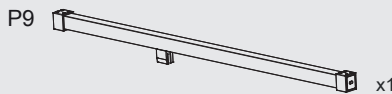
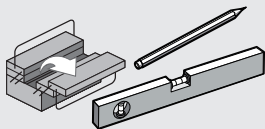
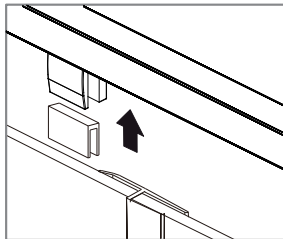
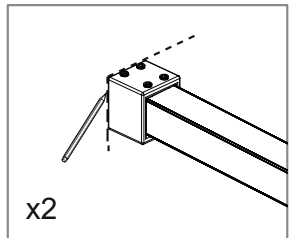
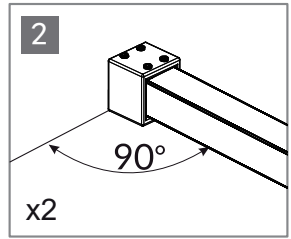
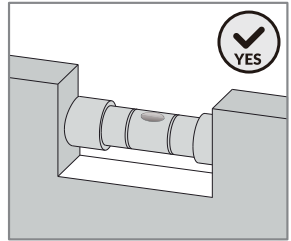
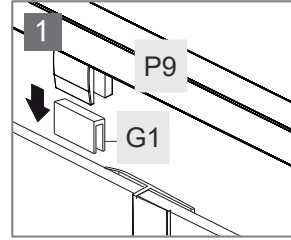
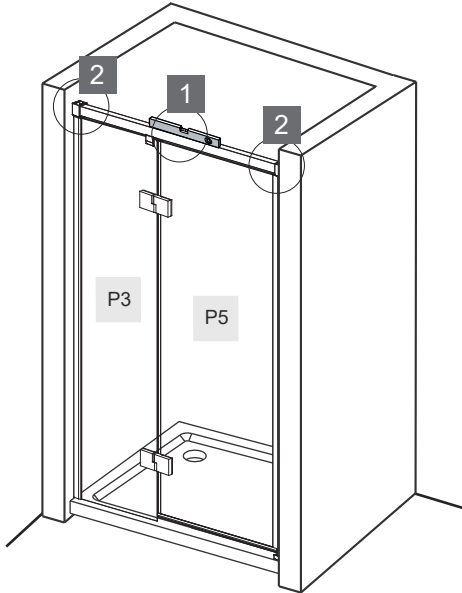
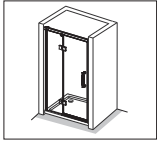

13.

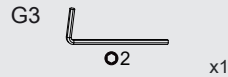
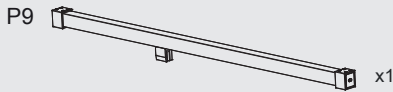
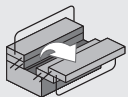
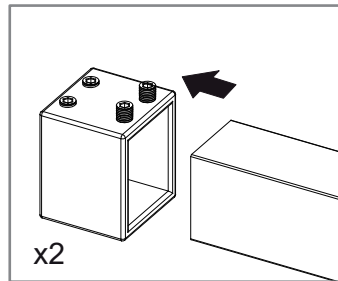
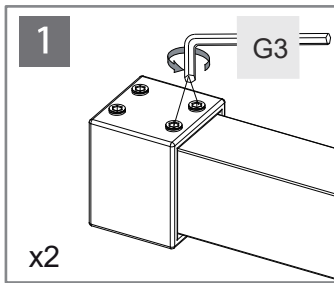
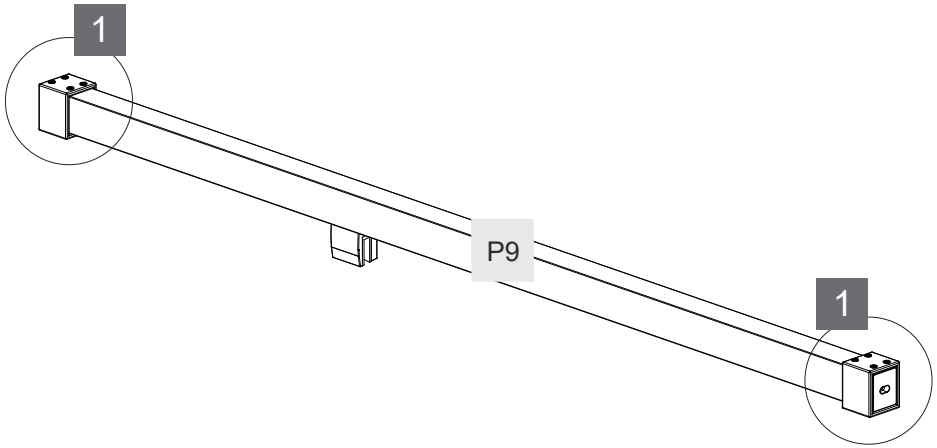
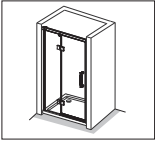

14.

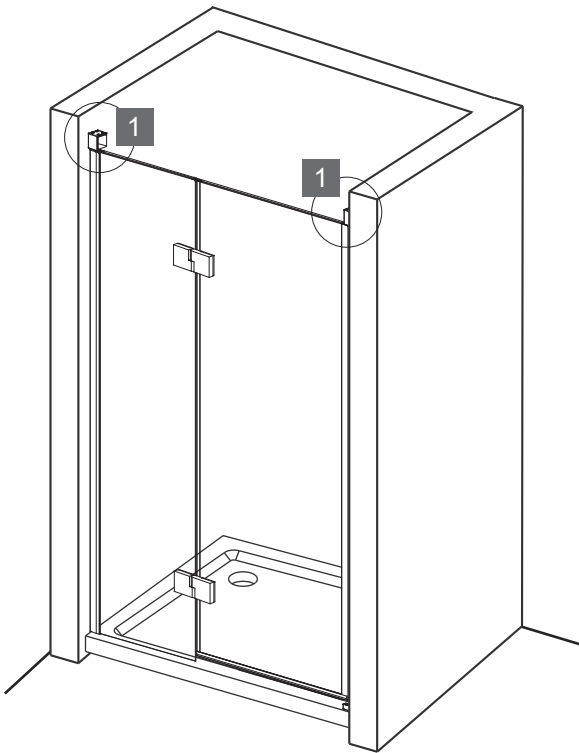
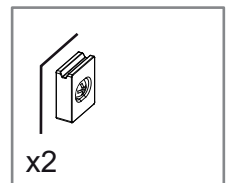
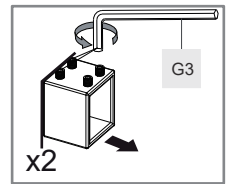
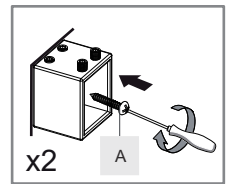
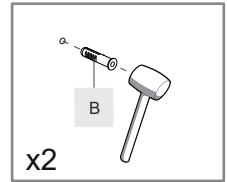
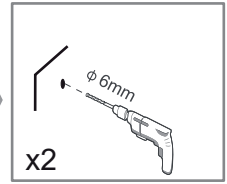
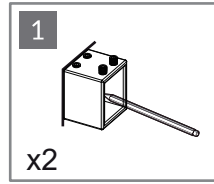
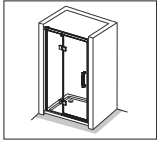

15.

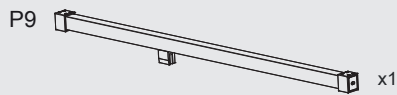
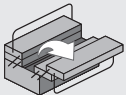
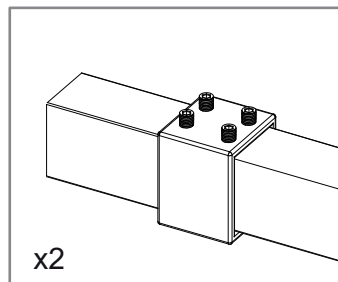
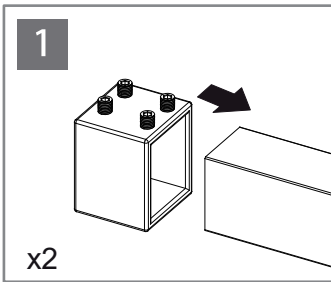
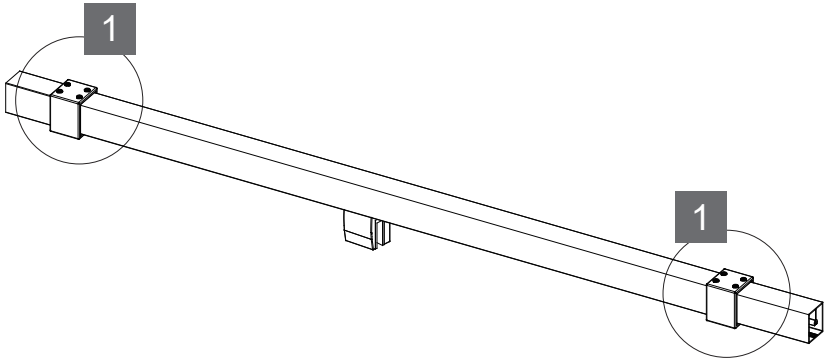
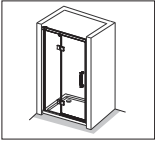

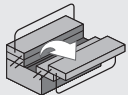
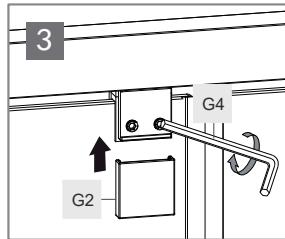
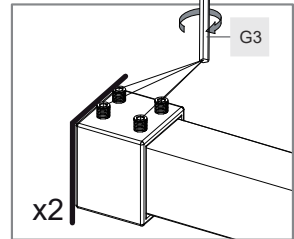
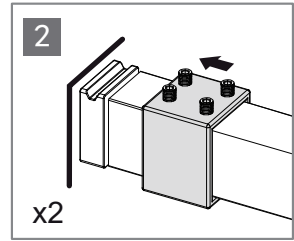
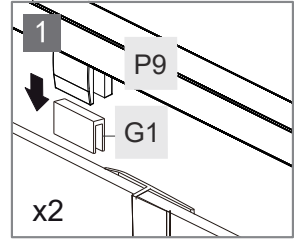
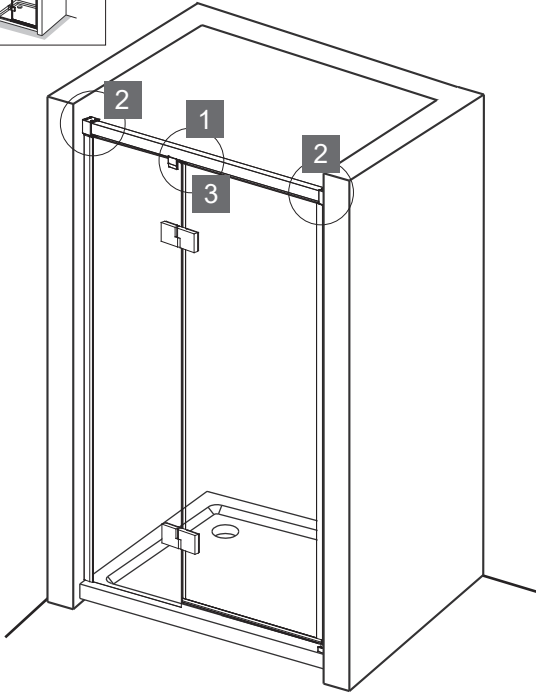
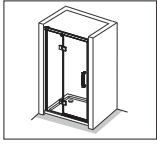

G1



x1



x1

G3

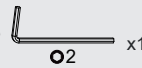

x1

G4

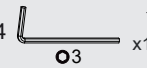

x1



17.

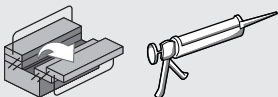
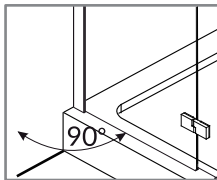
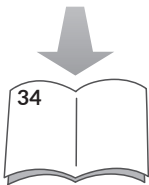
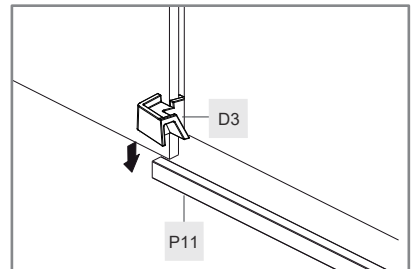
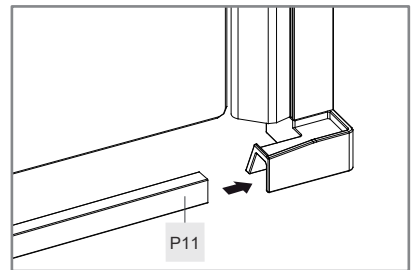
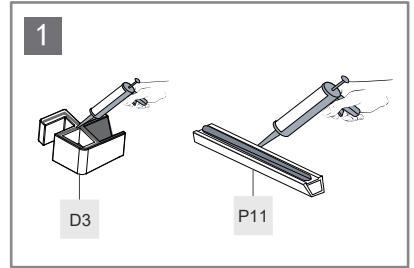
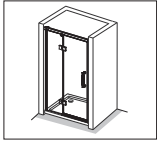
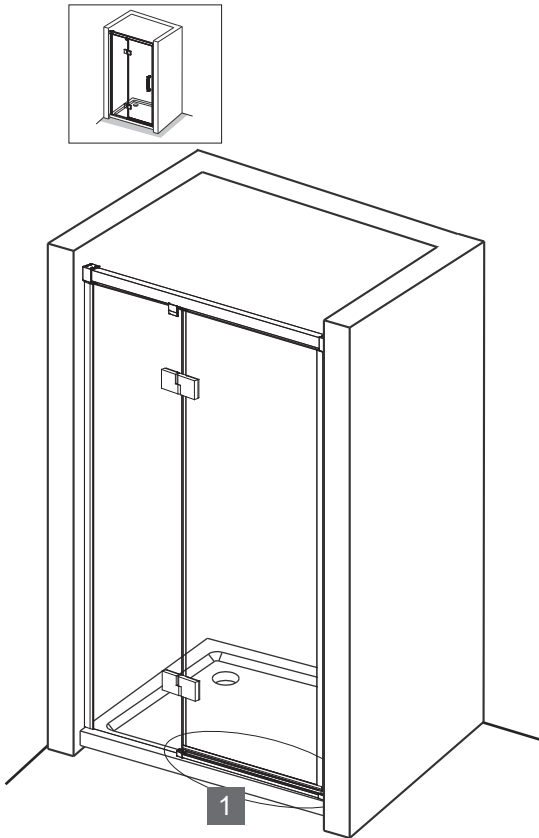

D3  x1

P11  x1



18.

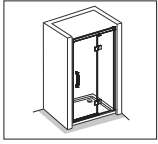

SIZE	X(mm)
800 × 2000	790-800
900 × 2000	890-900
1000 × 2000	990-1000
1200 × 2000	1190-1200

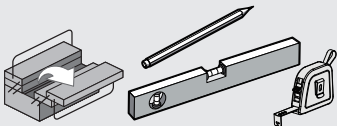
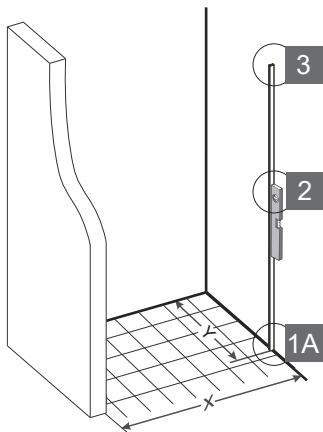
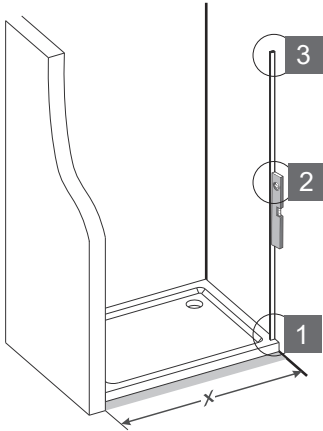
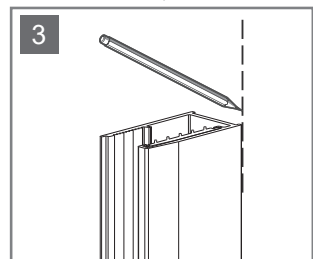
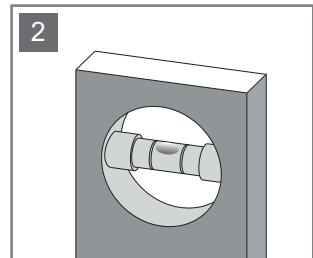
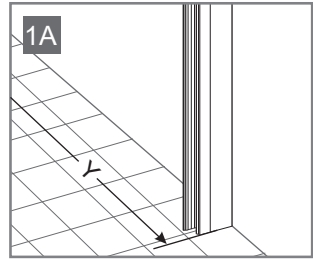
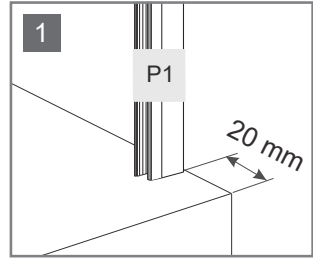

P1  x1



19.

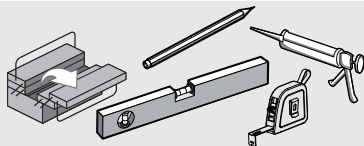
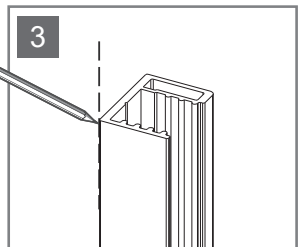
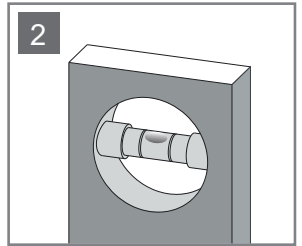
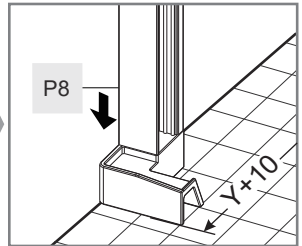
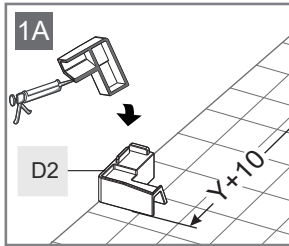
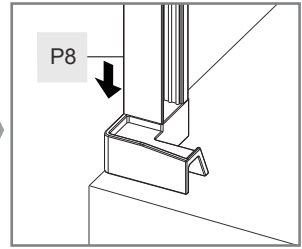
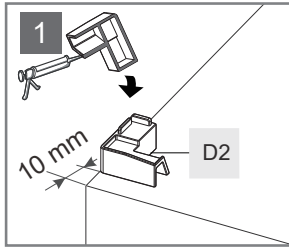
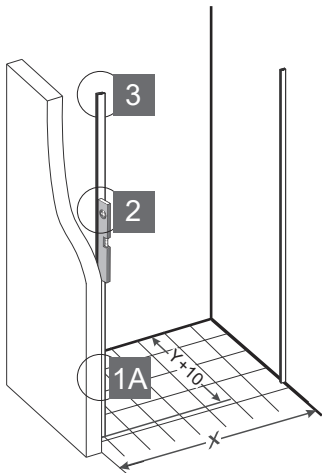
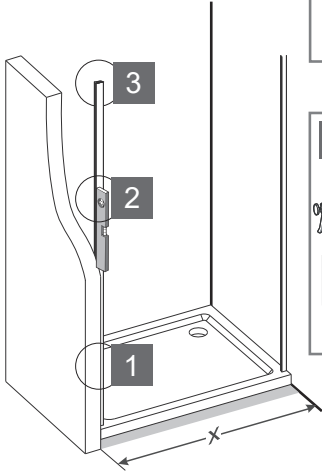
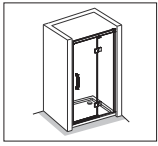

D2  x1

P8  x1



20.

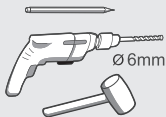
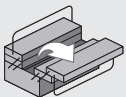
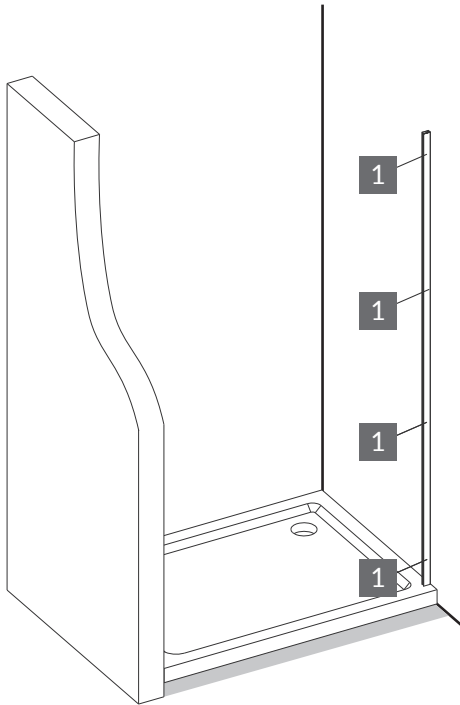
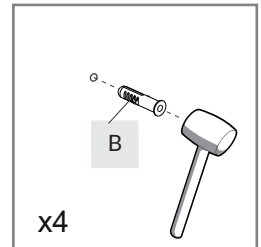
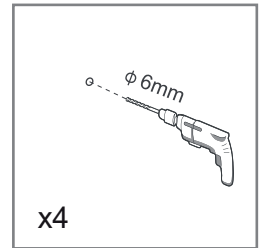
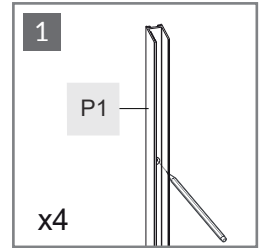
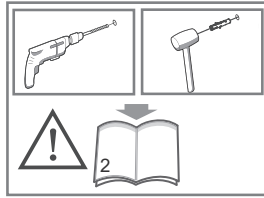
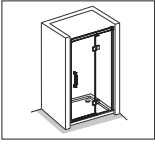

B



x4



21.

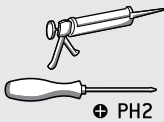
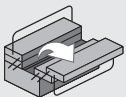
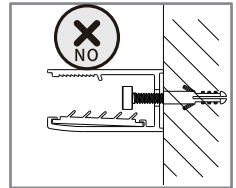
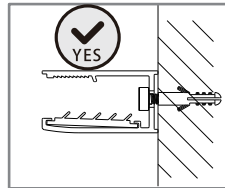
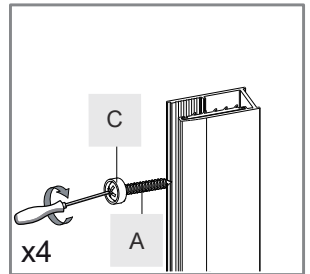
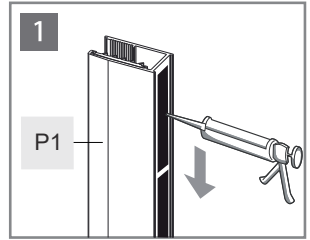
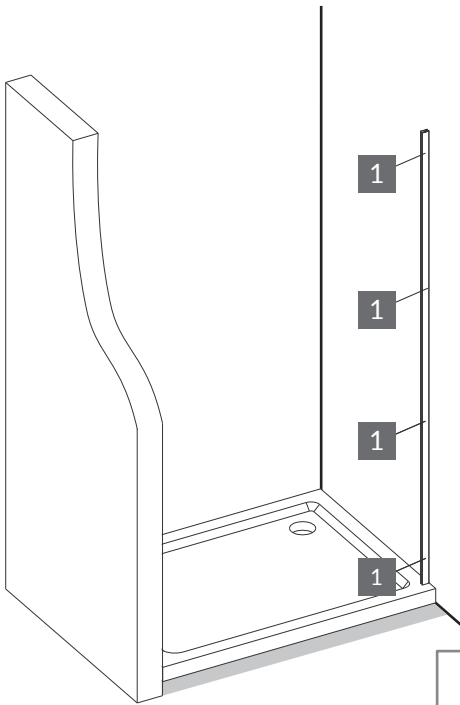
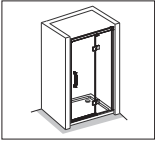

A



x4

C



x4



22.

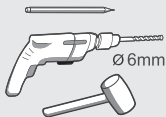
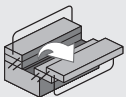
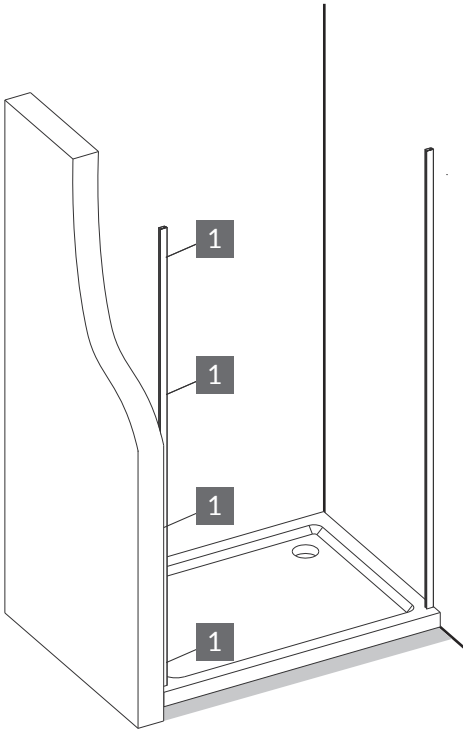
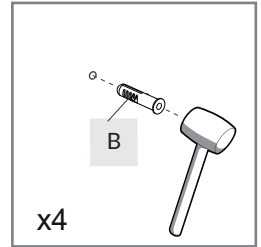
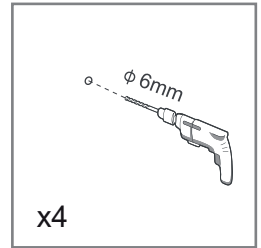
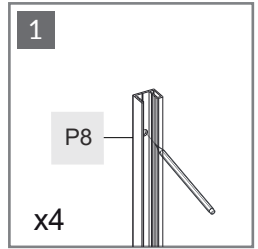
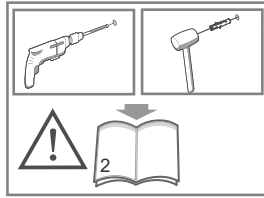
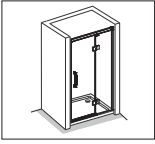

B



x4



23.

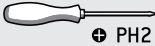
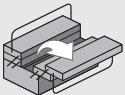
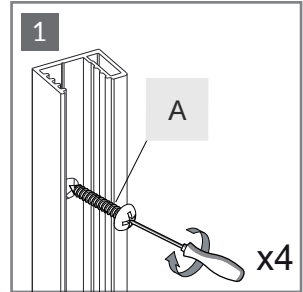
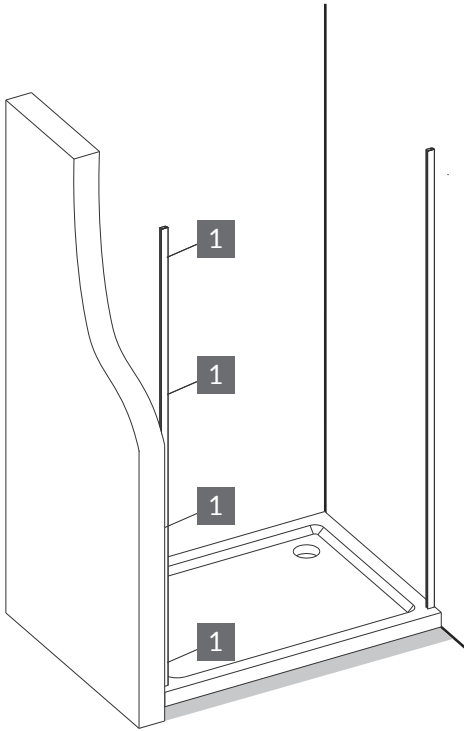
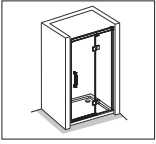

A



x4



24.

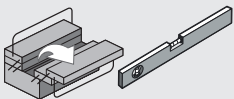
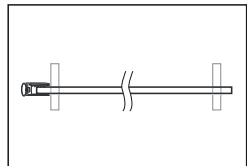
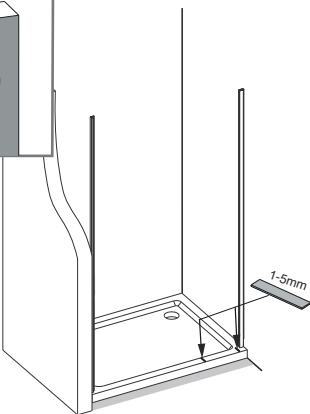
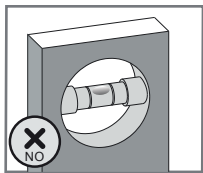
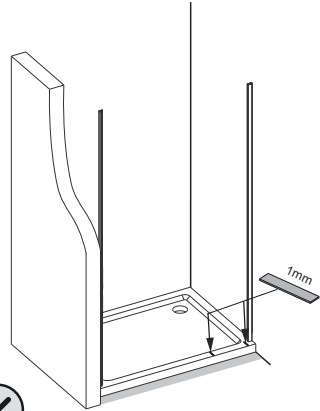
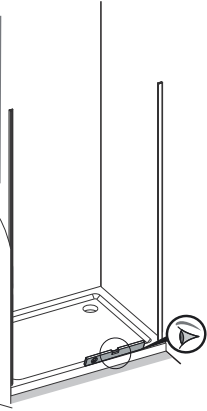
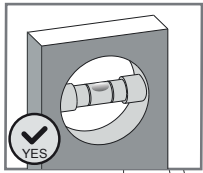
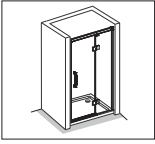

F1



x2

F2



x2

F3



x2



25.

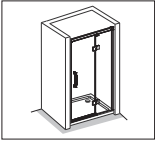

SIZE	X(mm)
800 × 2000	426
900 × 2000	526
1000 × 2000	626
1200 × 2000	726

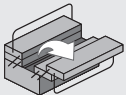
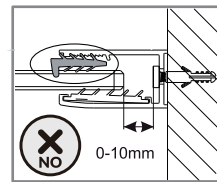
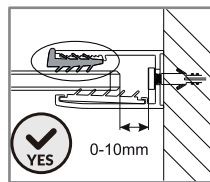
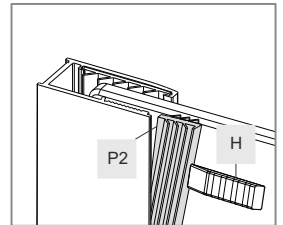
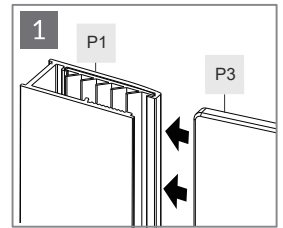
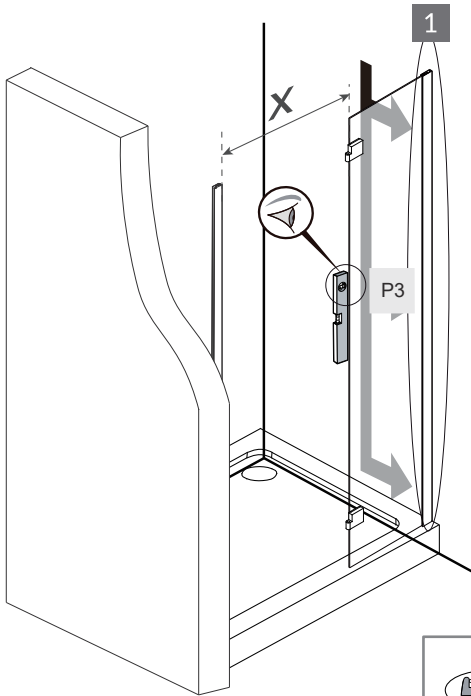
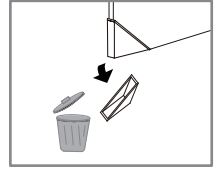
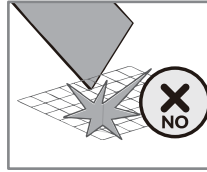

P2 ————— x1

H ————— x1

P3 ————— x1



26.

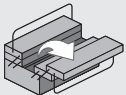
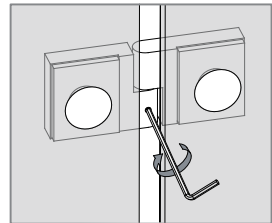
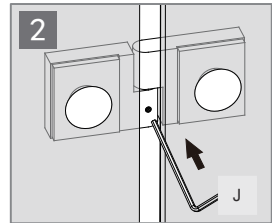
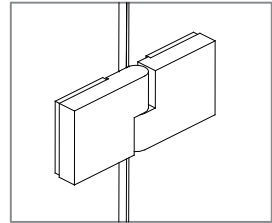
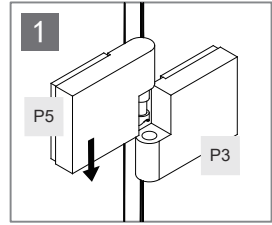
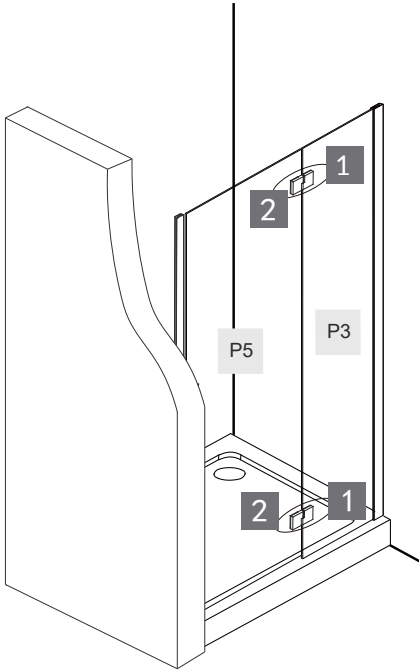
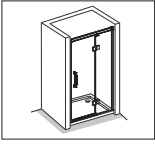

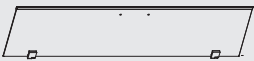
P5  x1

J  x1



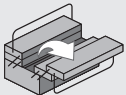
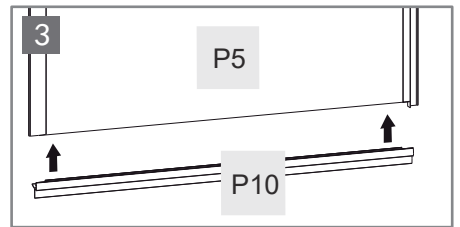
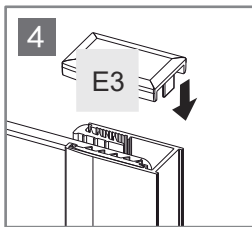
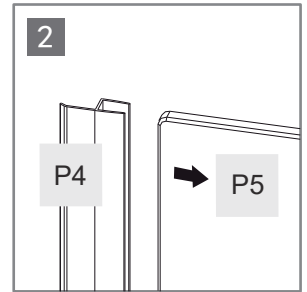
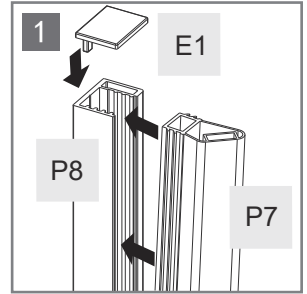
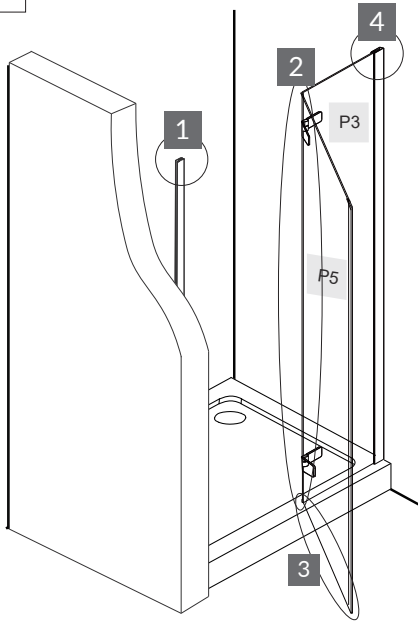
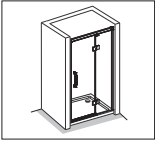

- | | | | | | |
|-----|--|----|----|--|----|
| P7 | | x1 | E1 | | x1 |
| P4 | | x1 | E3 | | x1 |
| P10 | | x1 | | | |



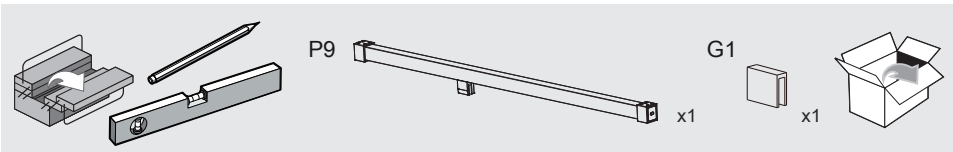
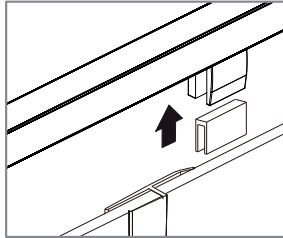
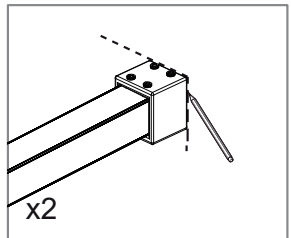
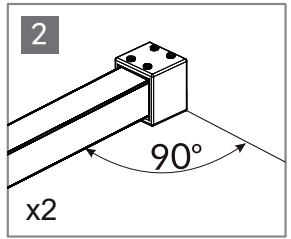
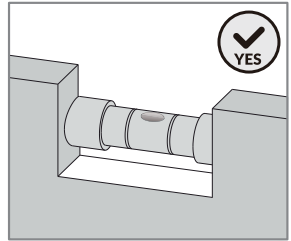
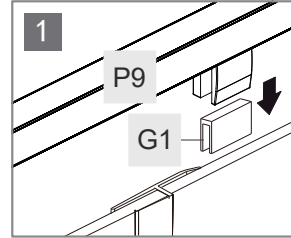
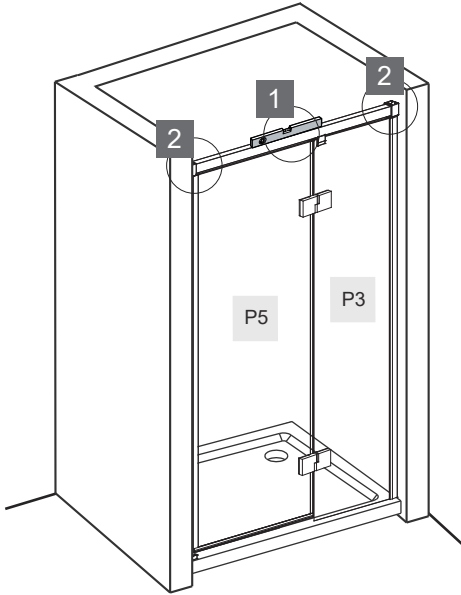
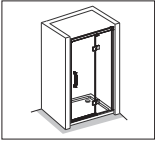

29.

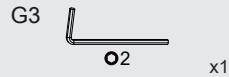
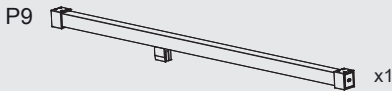
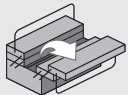
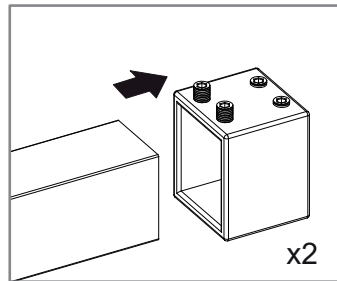
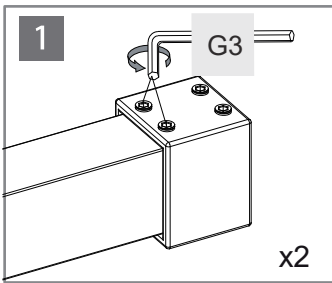
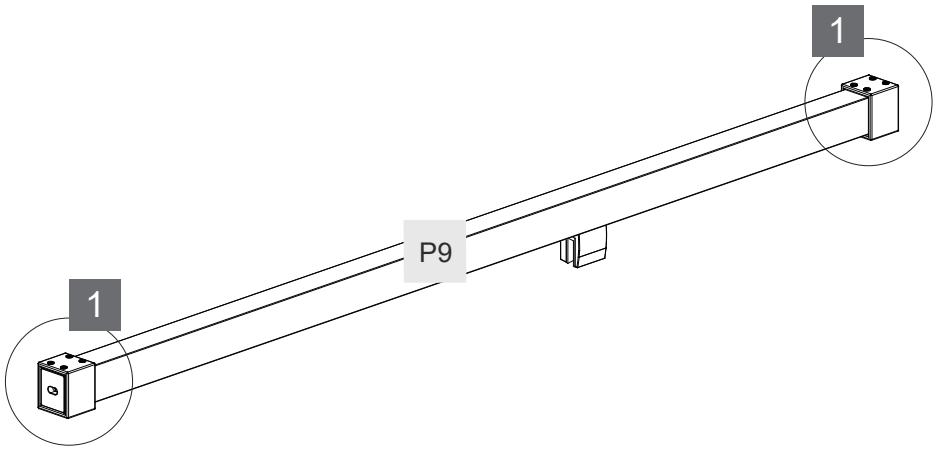
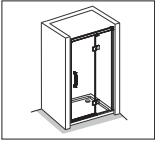

30.

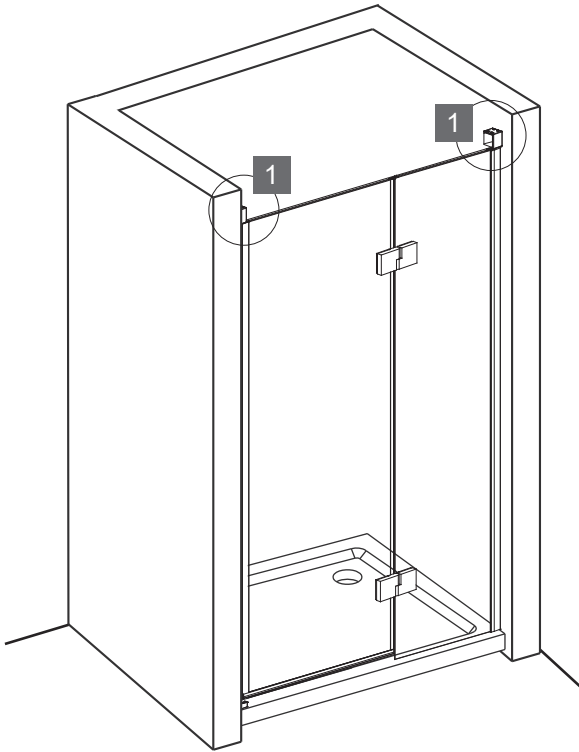
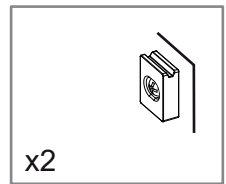
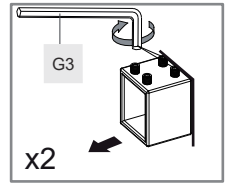
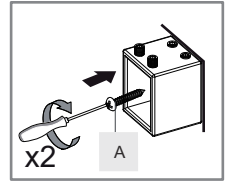
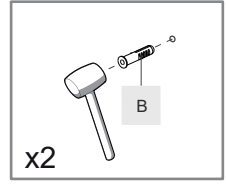
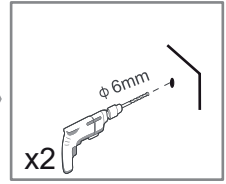
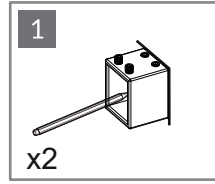
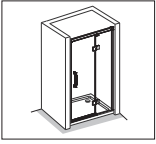

31.

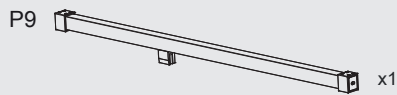
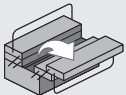
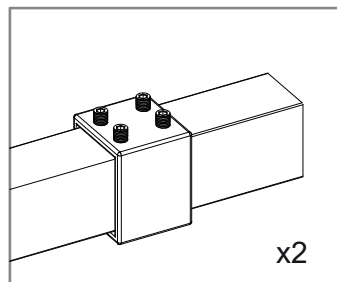
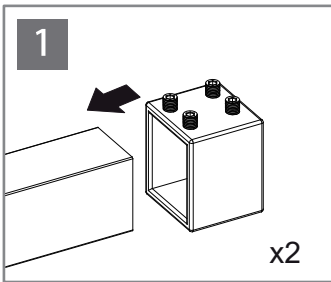
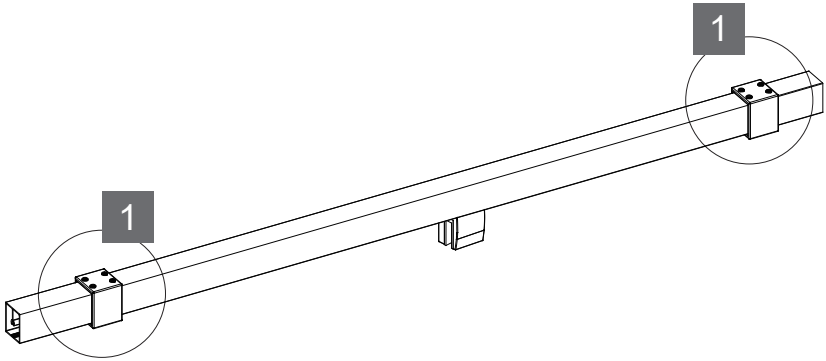
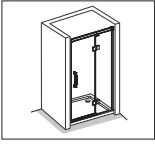

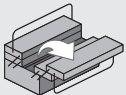
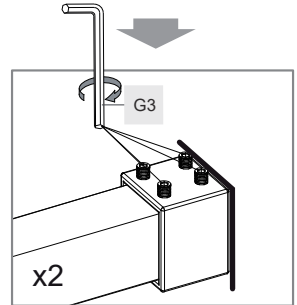
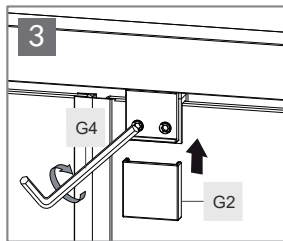
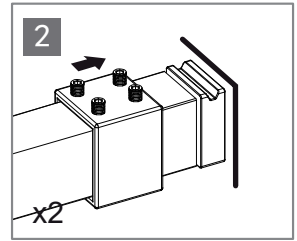
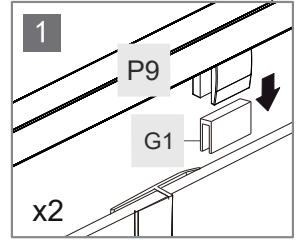
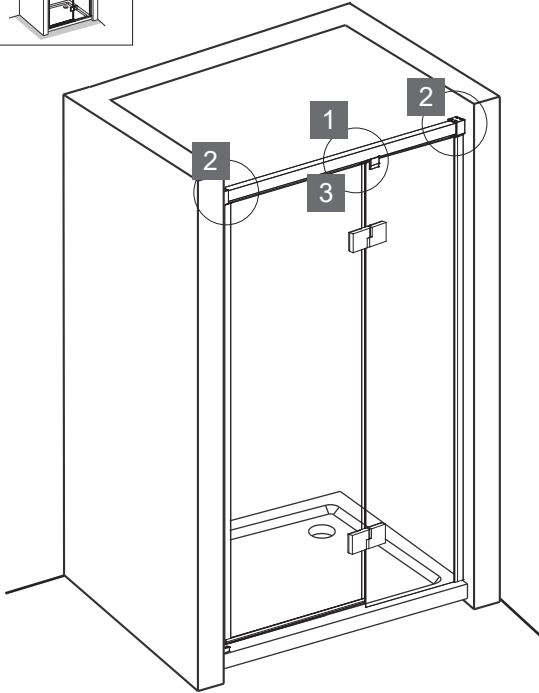
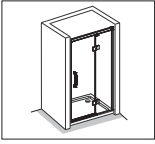

G1



x1

G2



x1

G3



x1

G4



x1



33.

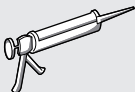
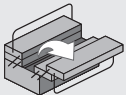
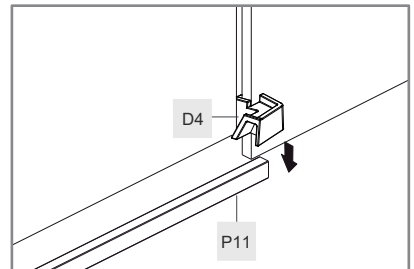
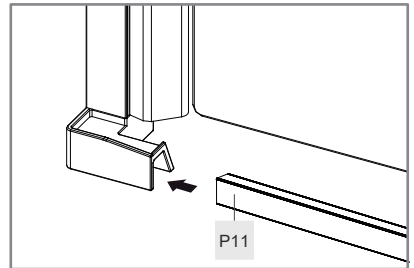
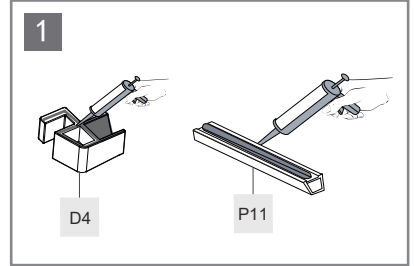
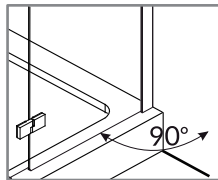
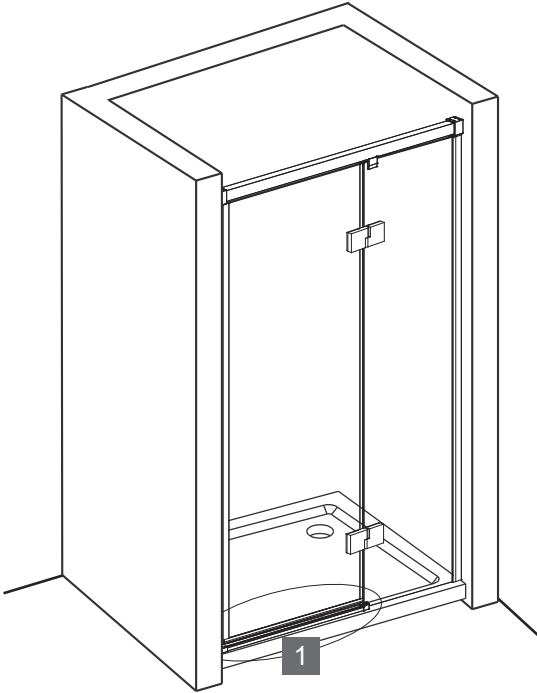
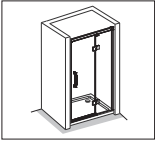

D4  x1

P11  x1



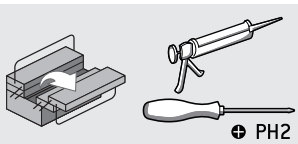
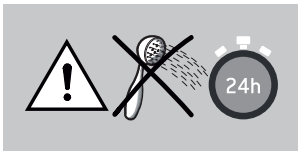
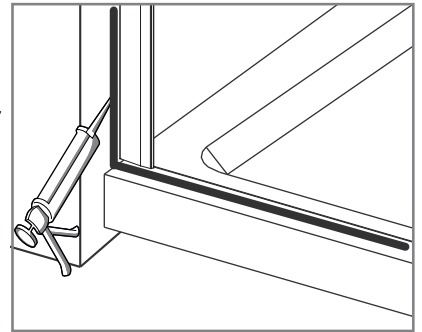
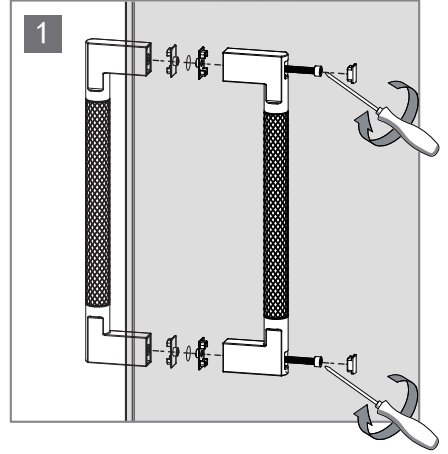
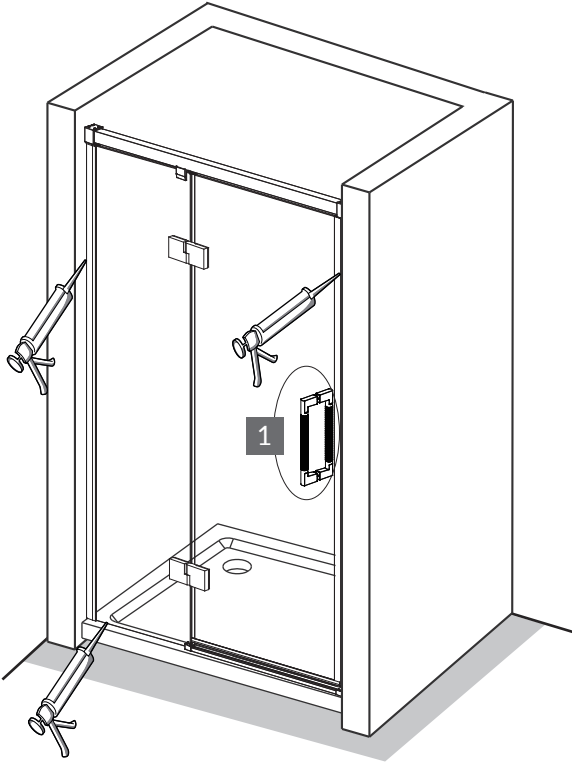

P6



x1





6.5<PH<7.5

