

# LARGA

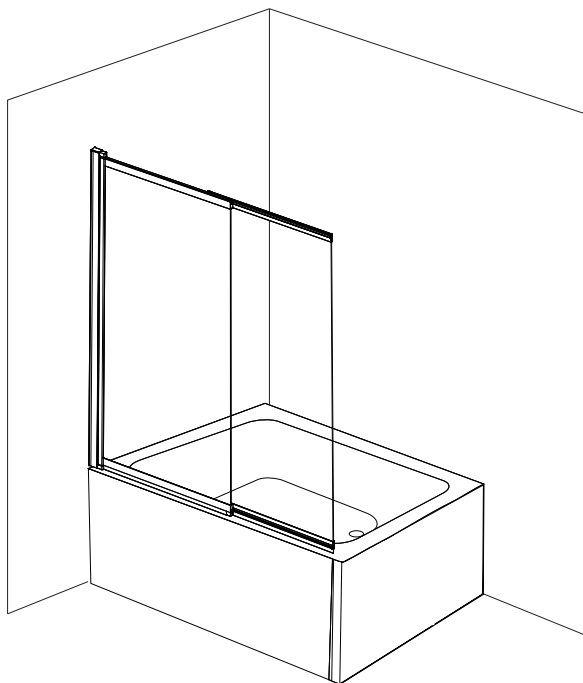

PL INSTRUKCJA MONTAŻU I EKSPLOATACJI

CZ NÁVOD NA MONTÁŽ A ÚDRŽBU

SK NÁVOD NA MONTÁŽ A ÚDRŽBU

EST PAIGALDUS- JA KASUTUSJUHEND

LT MONTAVIMO IR EKSPLOATAVIMO INSTRUKCIJA

LV MONTĀŽAS UN EKSPLUATĀCIJAS INSTRUKCIJA

DE MONTAGE- UND AUFBAUANLEITUNG

RO INSTRUCȚIUNI DE MONTAJ ȘI OPERARE

HU SZERELÉSI ÉS ÜZEMELTETÉSI ÚTMUTATÓ

UA ІНСТРУКЦІЯ З МОНТАЖУ І ЕКСПЛУАТАЦІЇ

BY ІНСТРУКЦЫЯ ПА МАНТАЖЫ І ЭКСПЛУАТАЦЫІ

RU ИНСТРУКЦИЯ ПО МОНТАЖУ И ЭКСПЛУАТАЦИИ

EN INSTRUCTIONS FOR ASSEMBLY AND USE

FR INSTALLATION ET UTILISATION - MODE

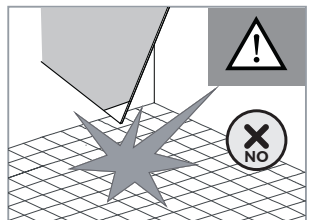
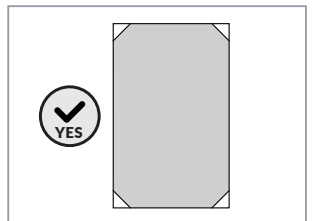
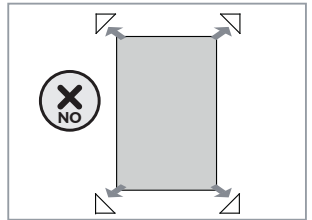
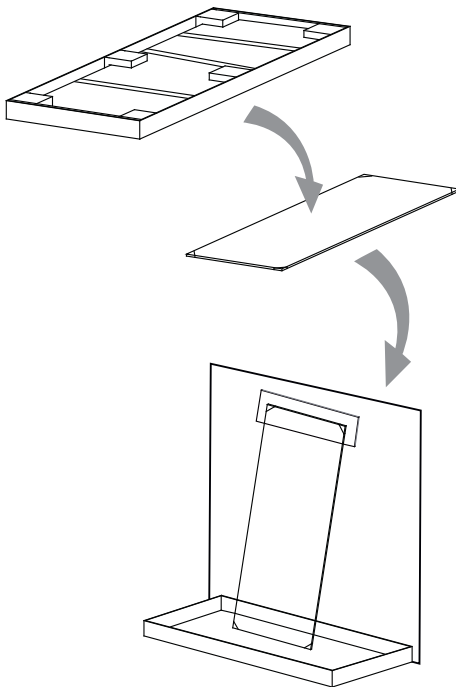
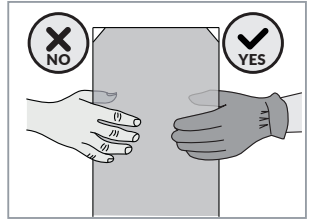
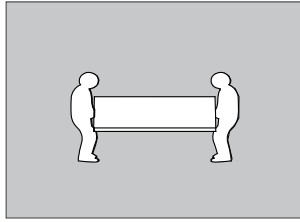
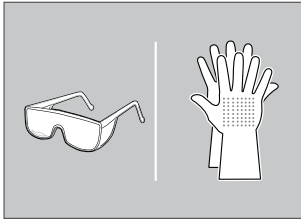
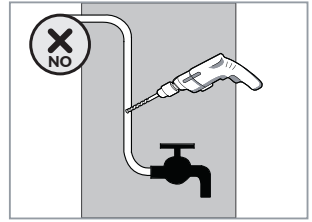
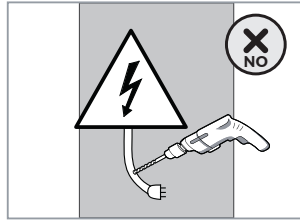
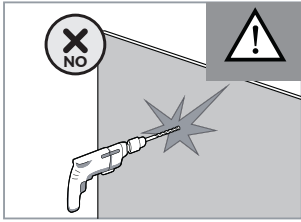

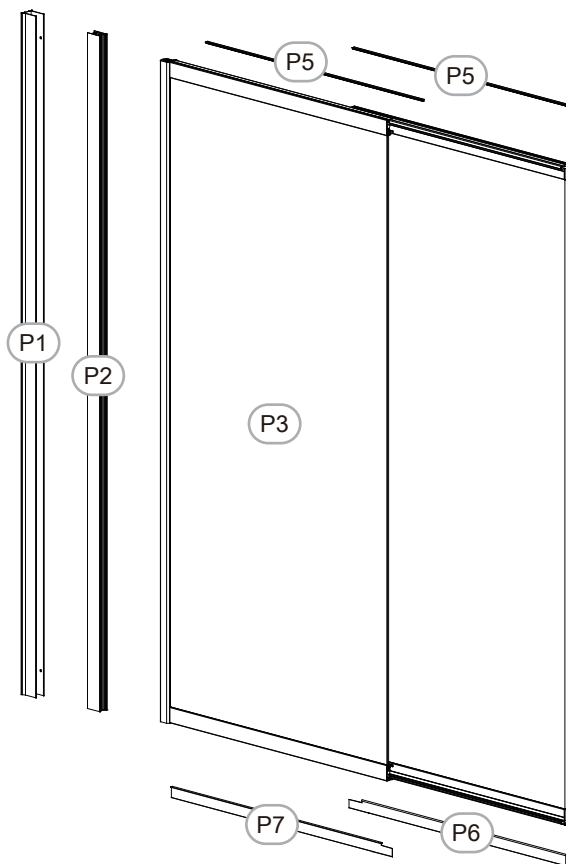



H1



x4

H2

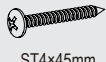

ST4×45mm

x4

H4



x3

H5



ST4×7mm

x3

H6



ST3.5×30mm

x4

H7



x1

H8



x1

H9



x1

H10



x1

H11



x1

H12



x2

H13



x2

H14



x2

H15



x2

H16



x1

H17



x1

H18

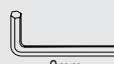

2mm

x1

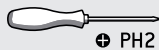
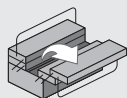

PH2



Ø 6mm



Ø 3mm

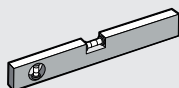
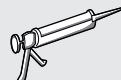
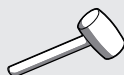
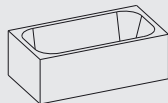

1.

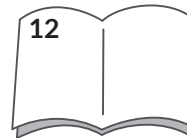
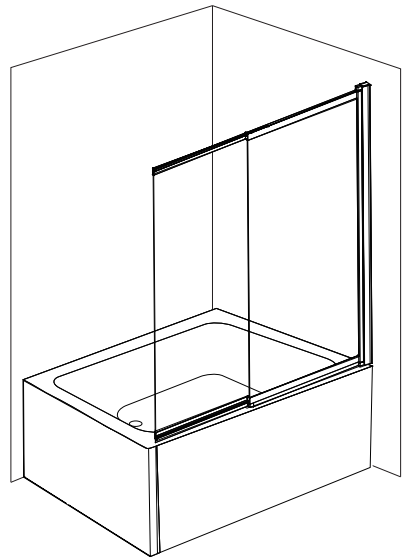
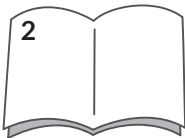
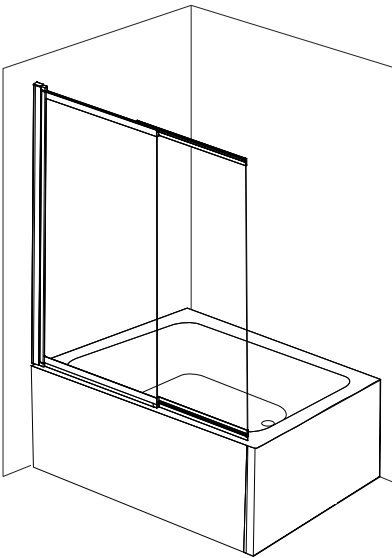

## 2.

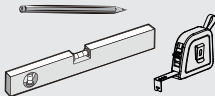
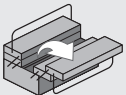
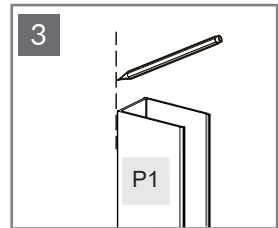
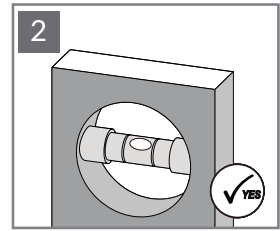
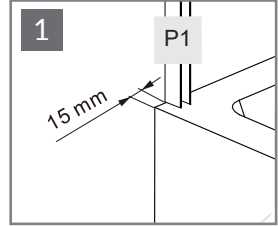
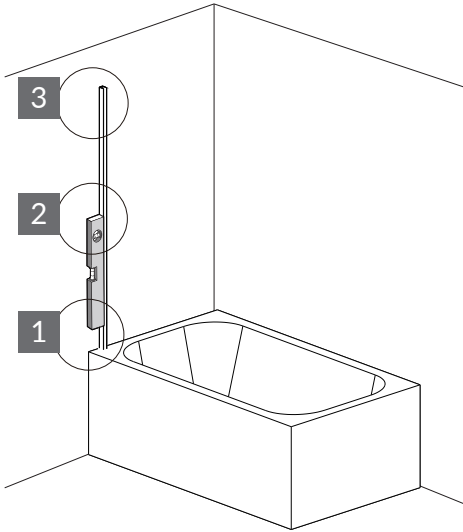
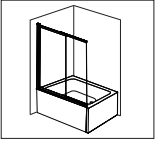

P1  ×1



### 3.

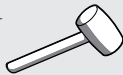
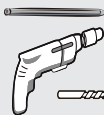
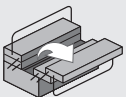
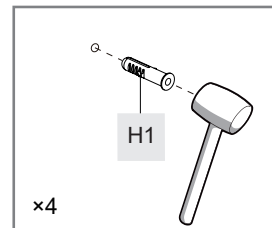
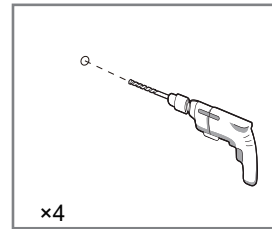
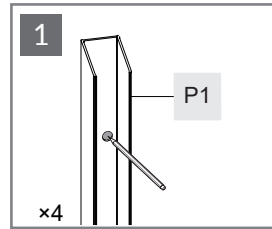
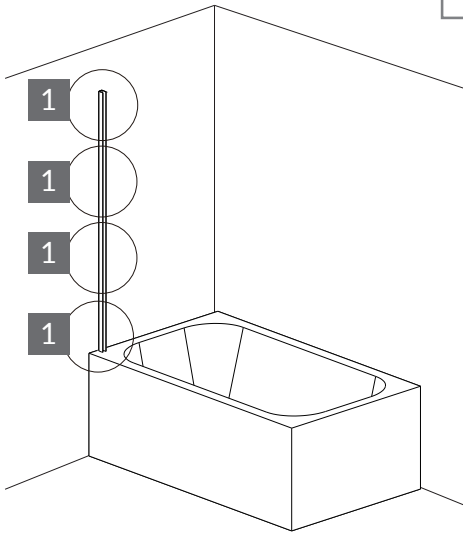
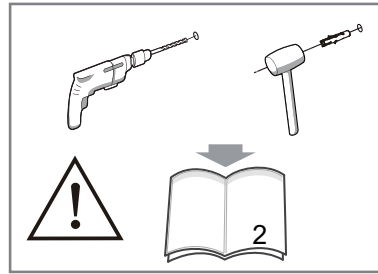
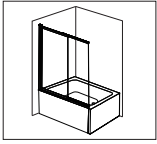

6mm

H1



x4



4.

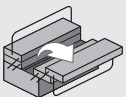
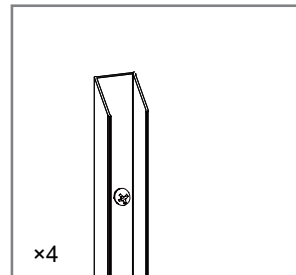
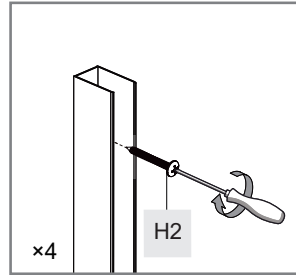
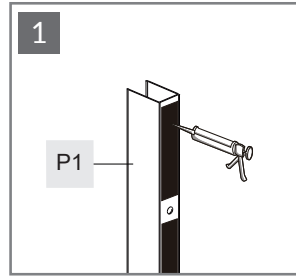
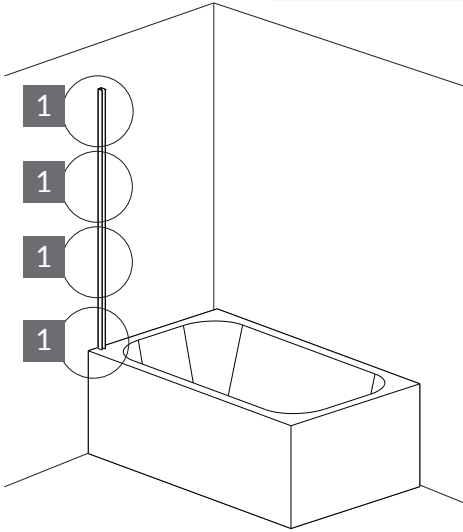
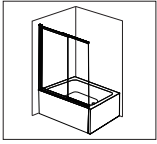

PH2

H2



x4







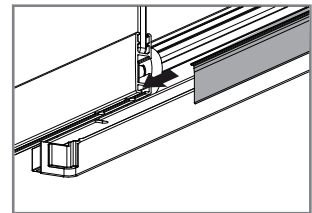
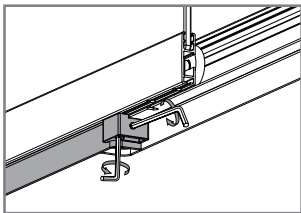
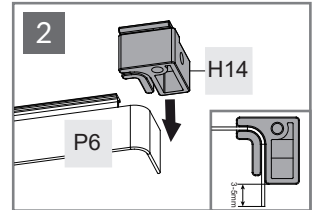
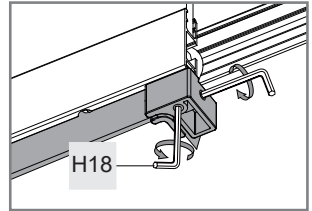
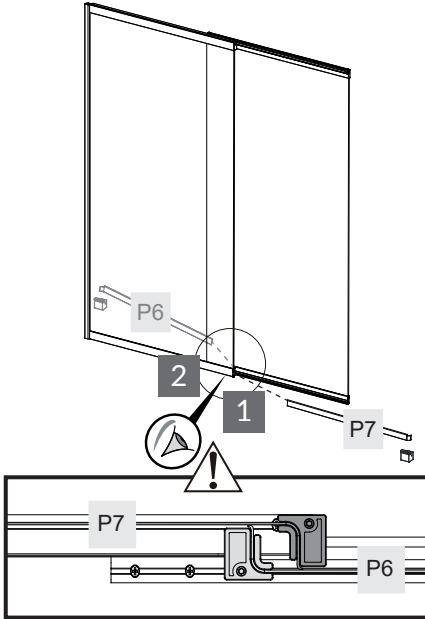
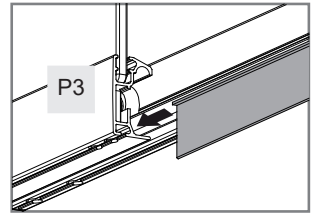
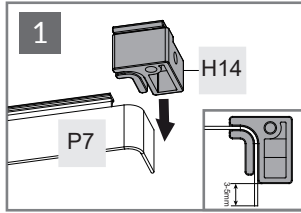
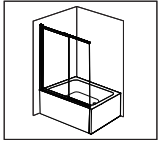

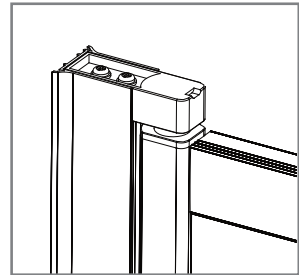
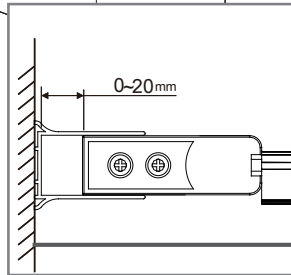
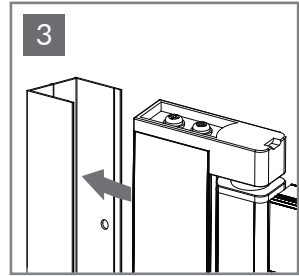
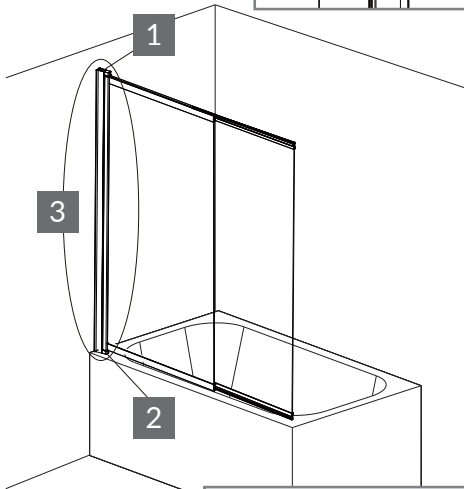
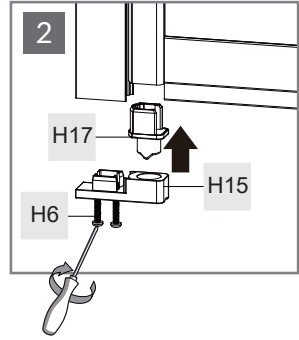
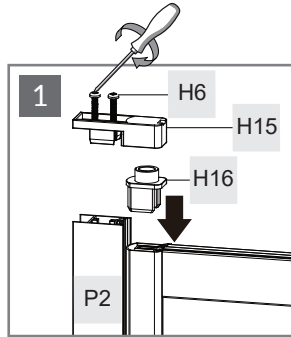
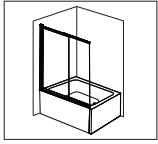

# 5.

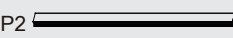

# 6.

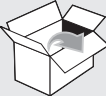

-  x1   
  x4   
  x2   
  x1   
  x1   
  PH2   
  ST3.5x30mm   
 

7.

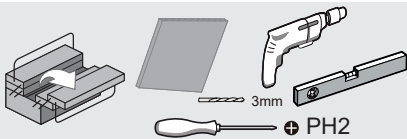
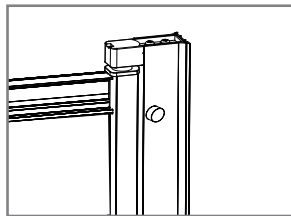
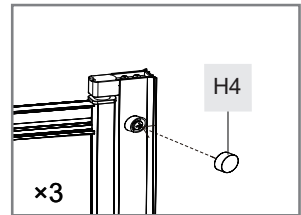
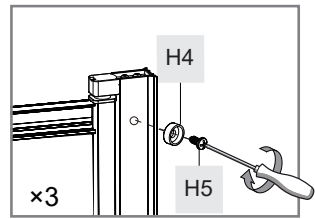
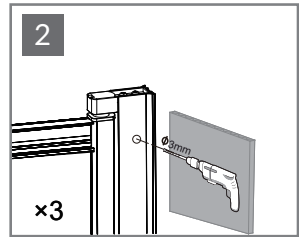
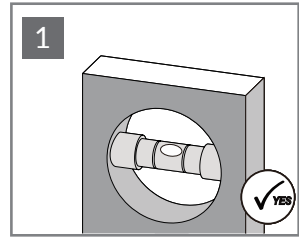
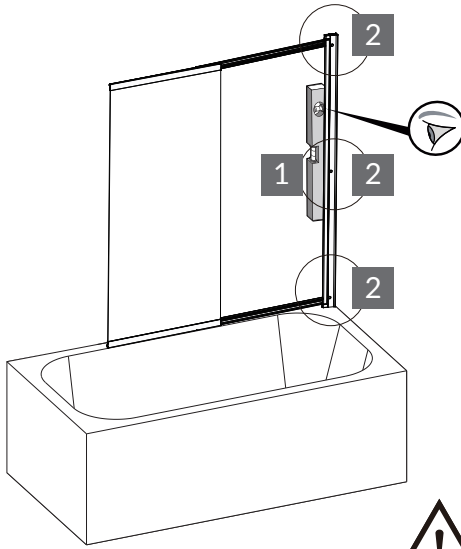

H4



x3

H5



x3



8.

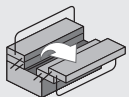
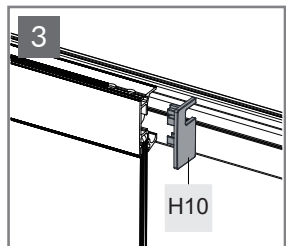
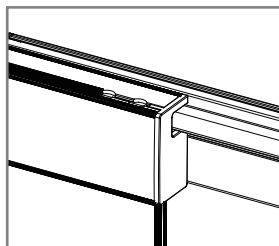
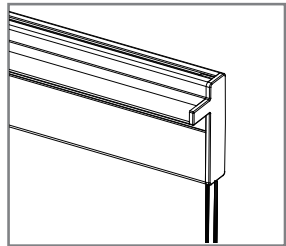
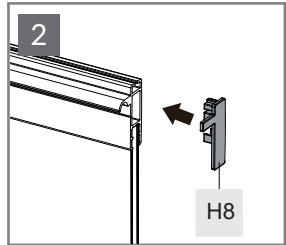
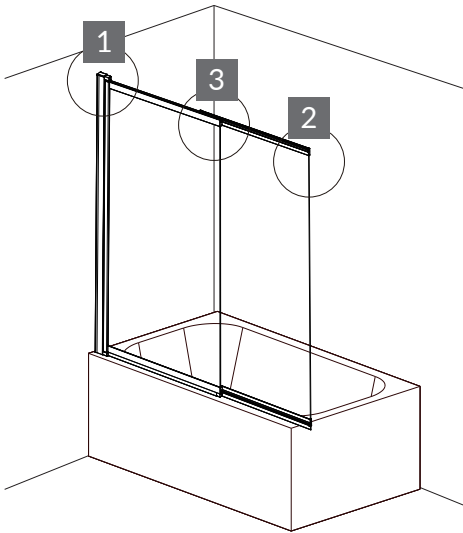
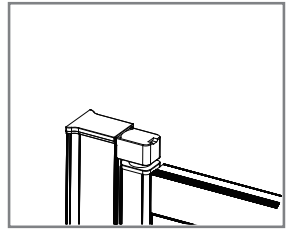
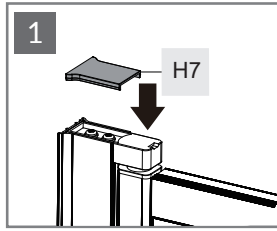
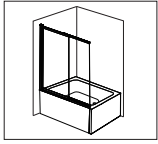

H7  ×1

H8  ×1

H10  ×1



9.

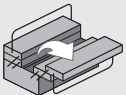
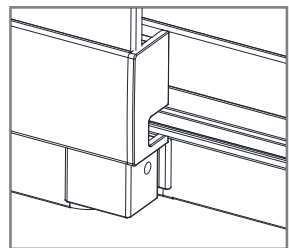
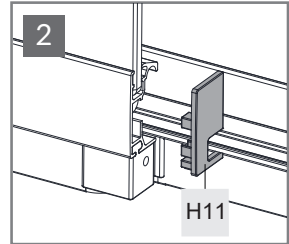
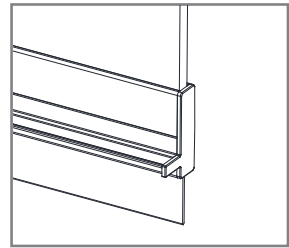
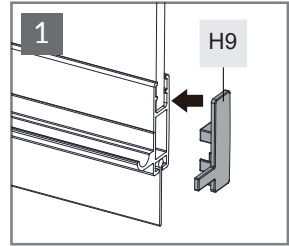
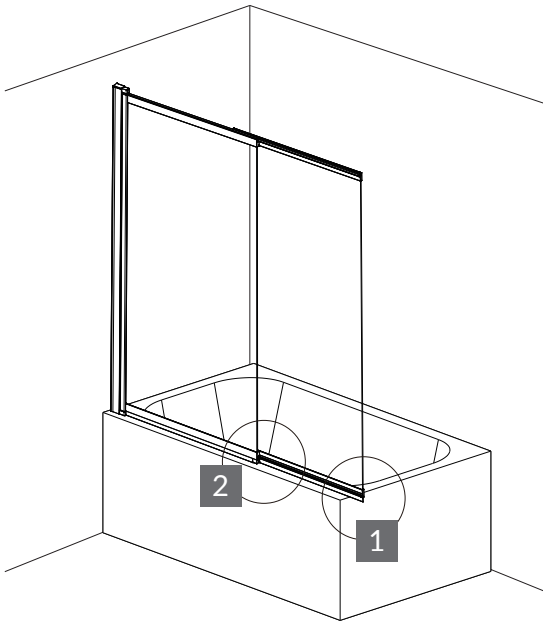
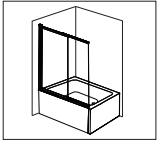

H9  x1

H11  x1



10.

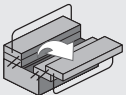
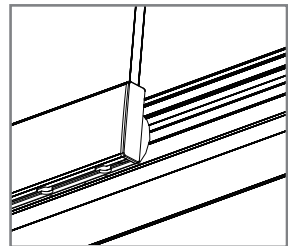
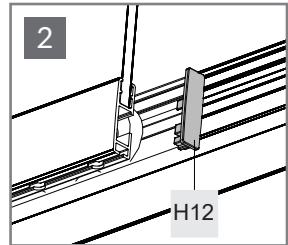
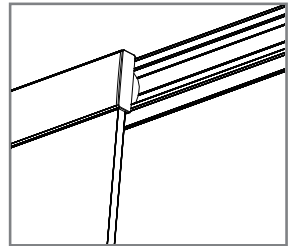
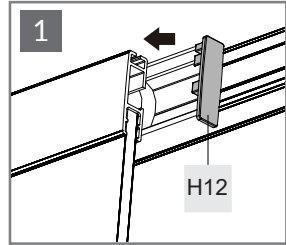
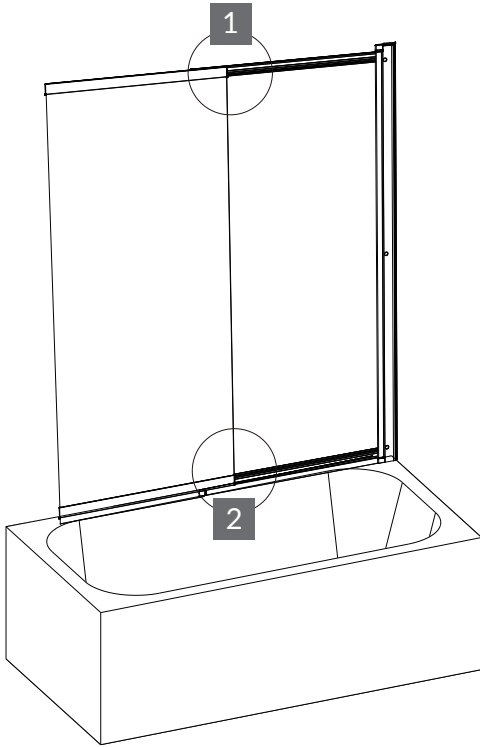
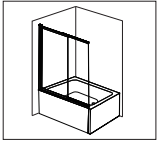

H12



×2



11.

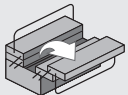
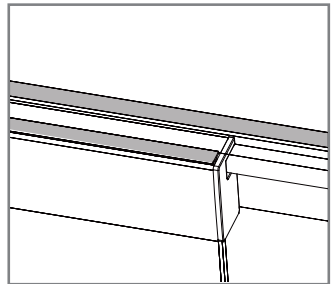
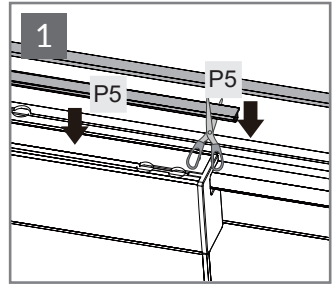
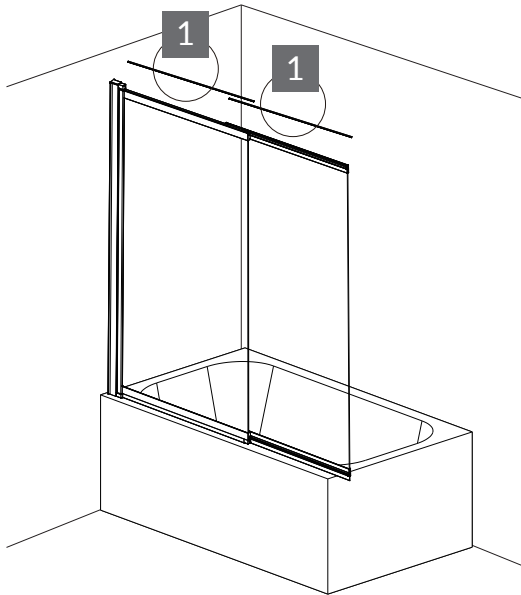
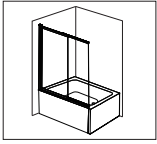

P5



×2



# 12.

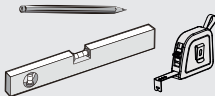
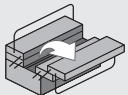
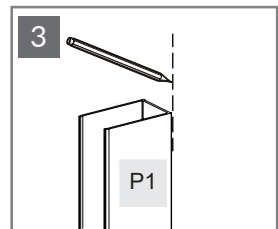
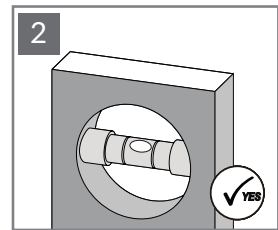
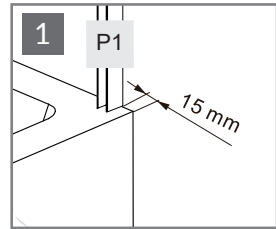
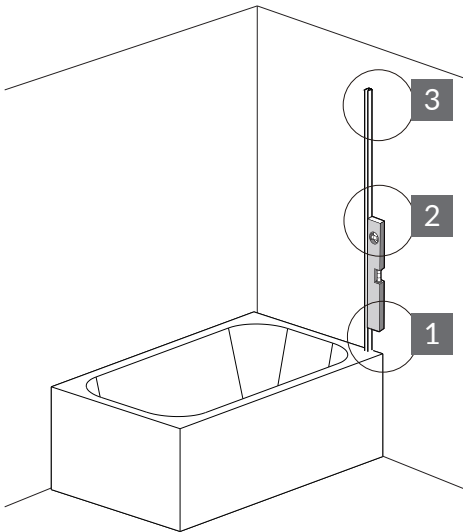
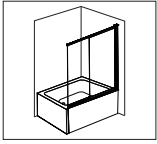

P1  x1





13.

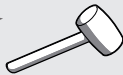
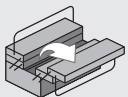
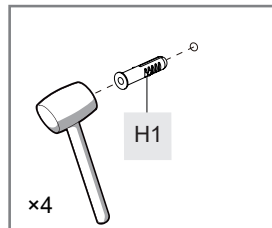
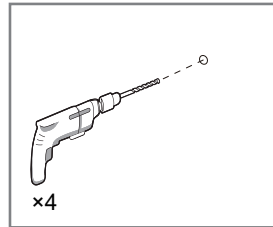
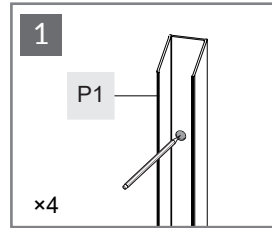
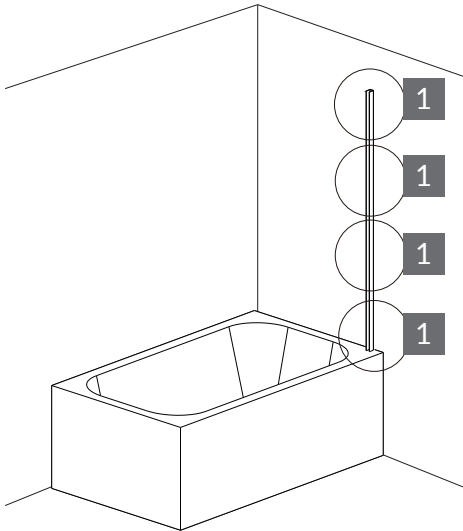
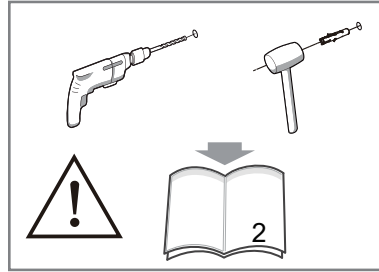
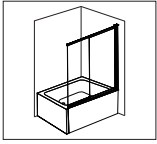

6mm

H1



x4



14.

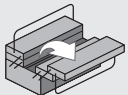
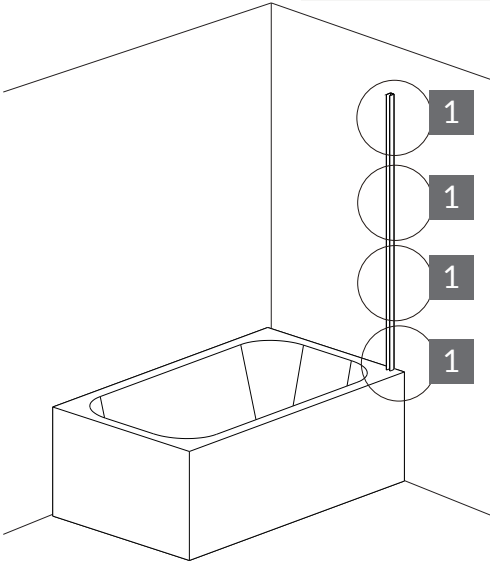
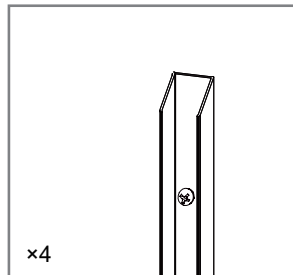
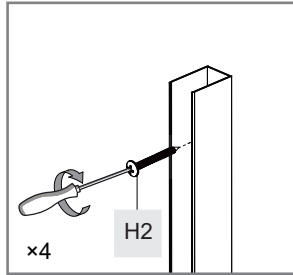
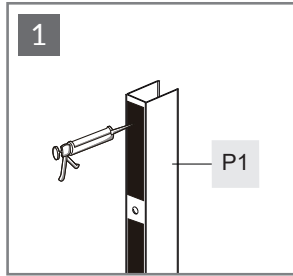
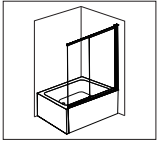

PH2

H2



x4



# 15.

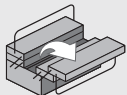
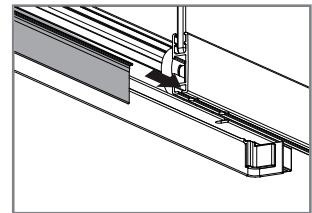
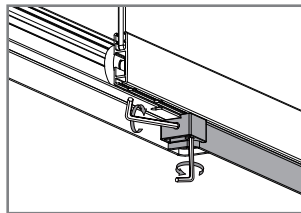
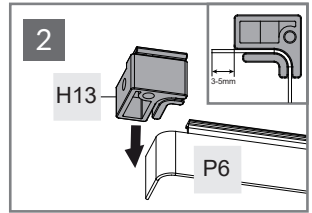
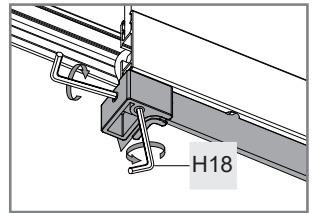
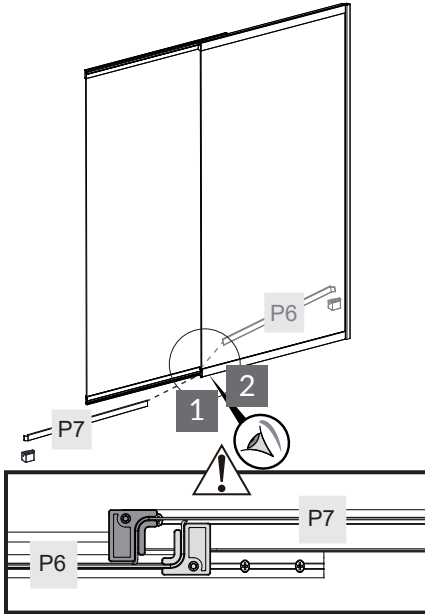
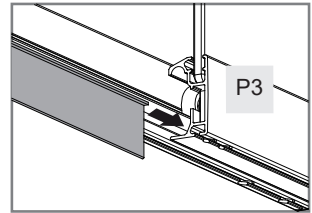
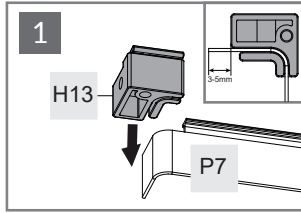
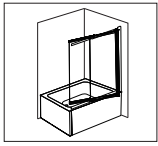

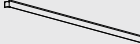
P6  x1

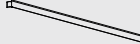
P7  x1

H13  x2







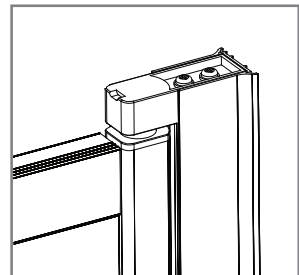
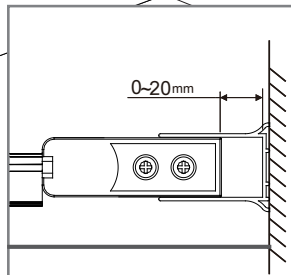
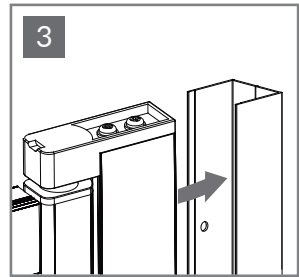
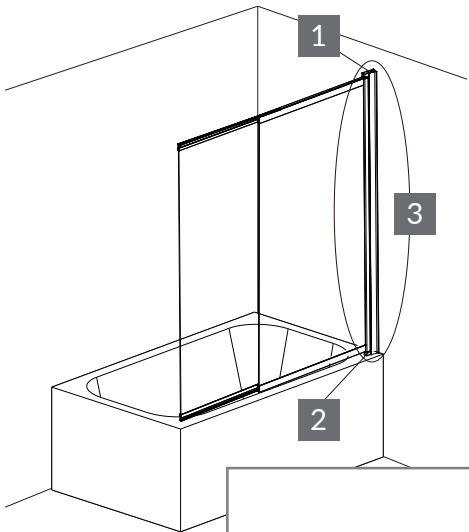
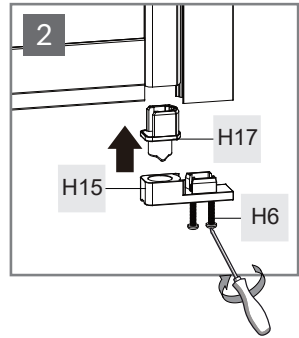
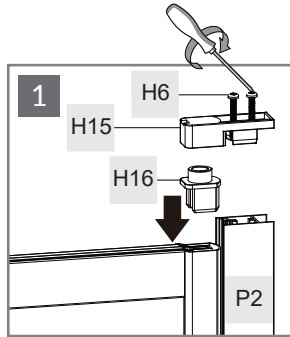
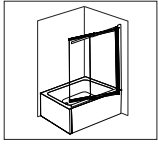

P3  x1

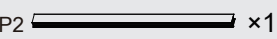
H18  x1

# 16.

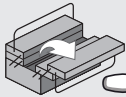

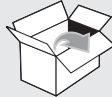
-  P2 x1
-  H6 x4
-  ST3.5x30mm x4
-  H16 x1
-  H15 x2
-  H17 x1
-  PH2 x1
- 

17.

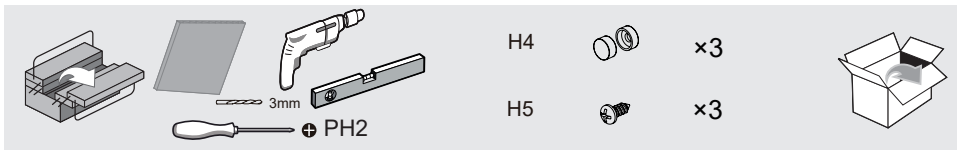
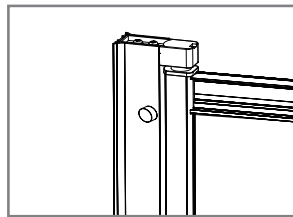
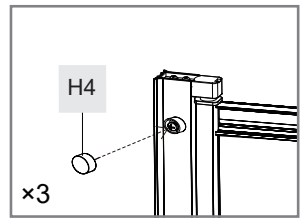
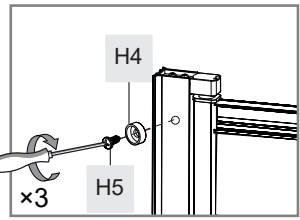
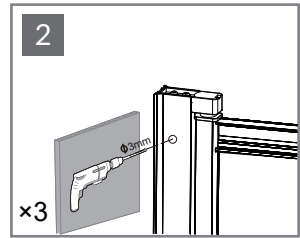
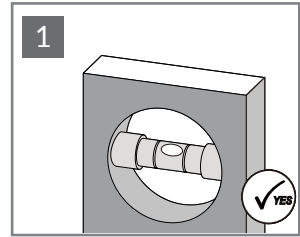
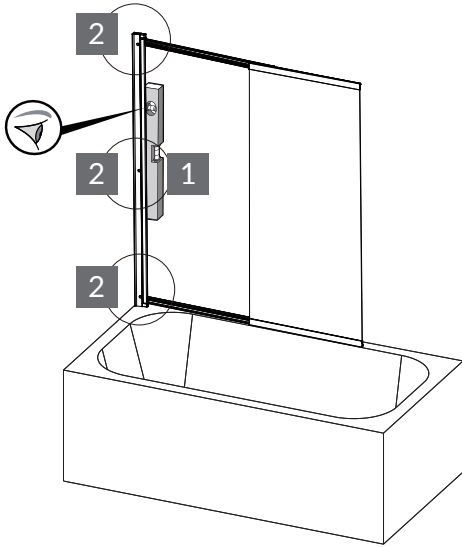
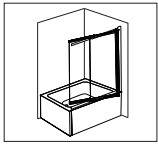

18.

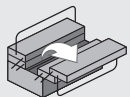
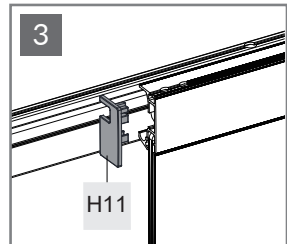
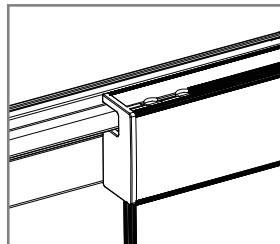
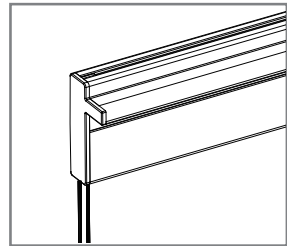
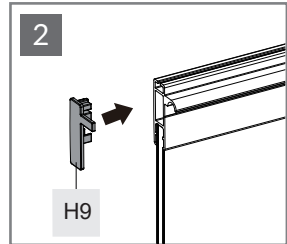
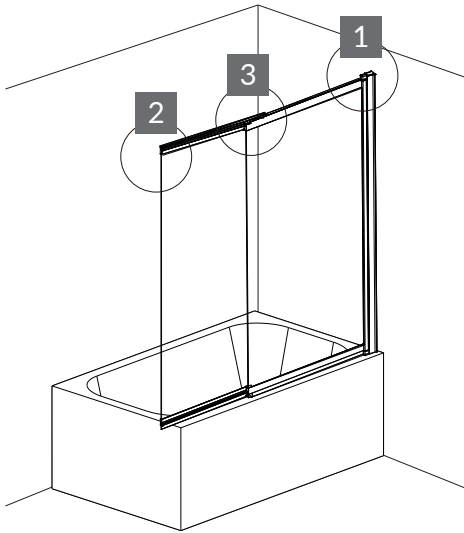
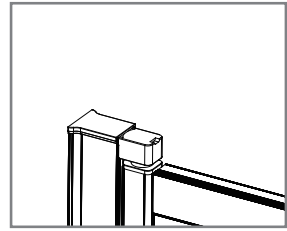
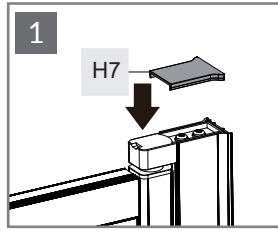
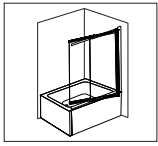

H7 ×1

H9 ×1

H11 ×1



19.

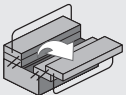
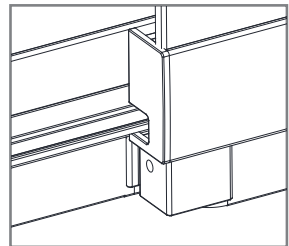
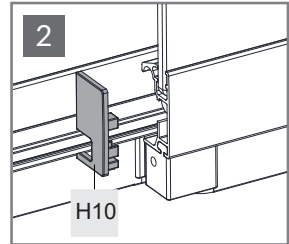
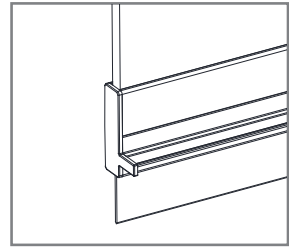
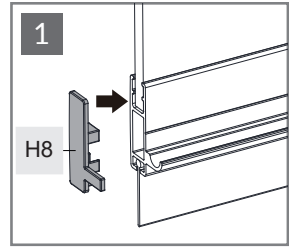
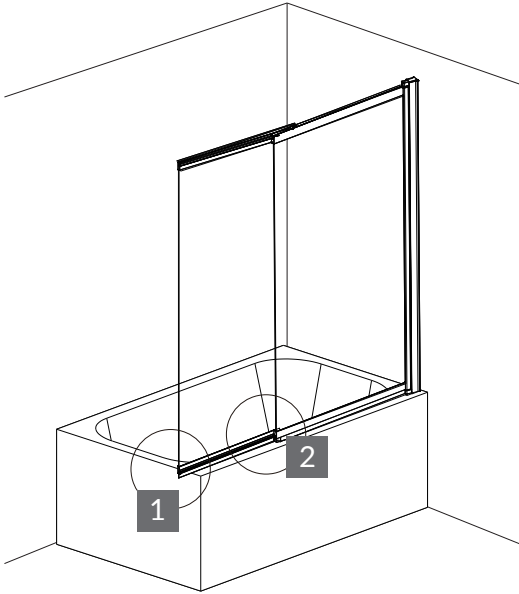
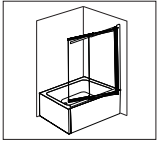

H8  x1

H10  x1



20.

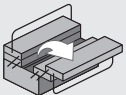
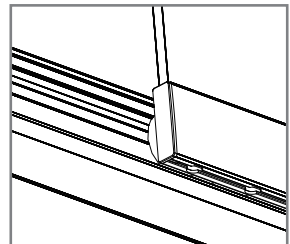
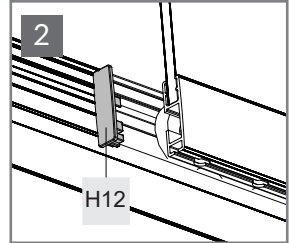
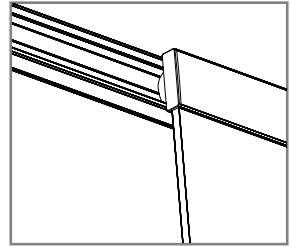
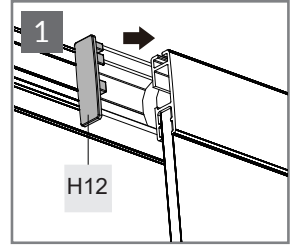
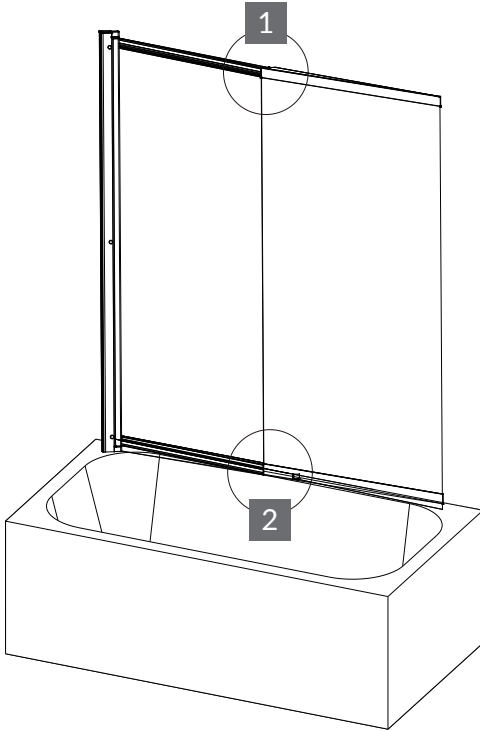
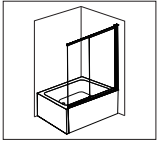

H12



×2





21.

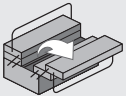
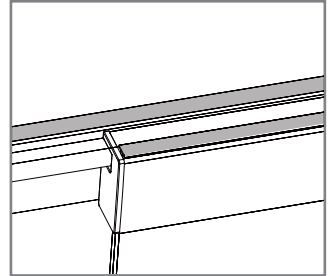
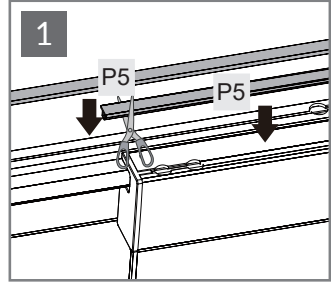
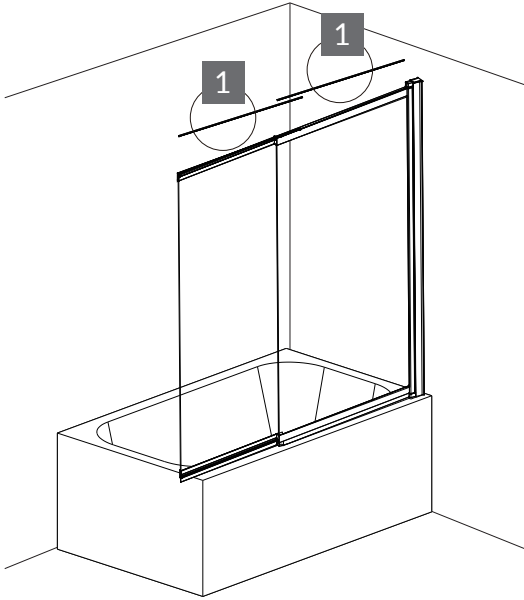
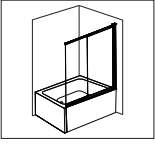

P5

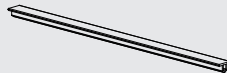

×2



22.

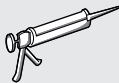
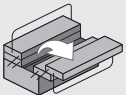
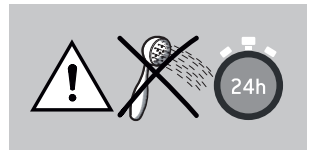
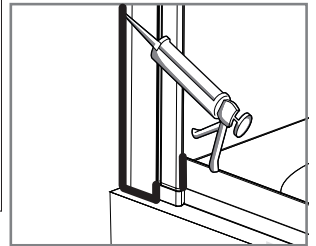
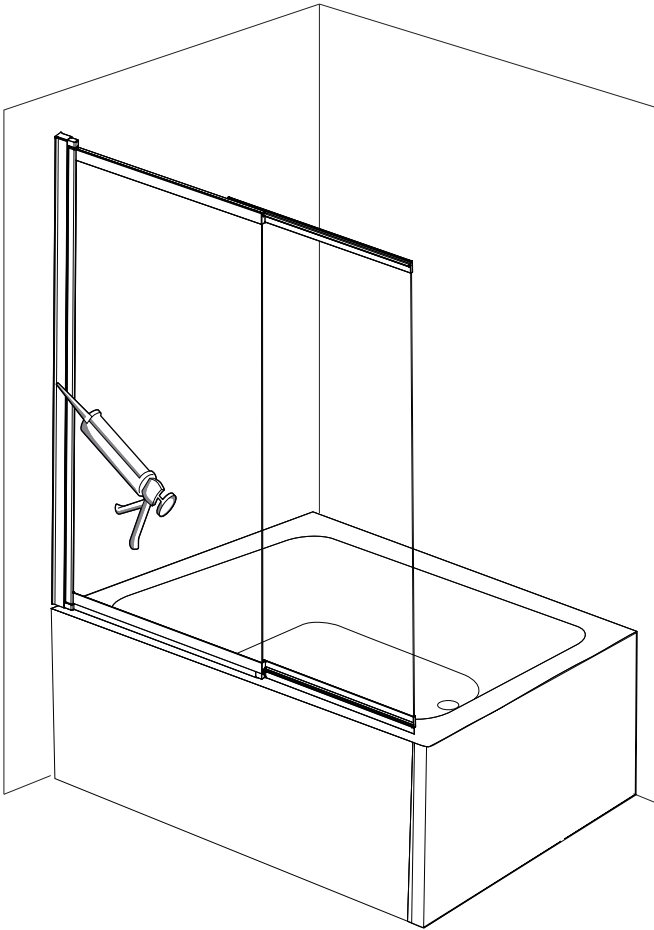



6.5 < PH < 7.5

