

Moduo

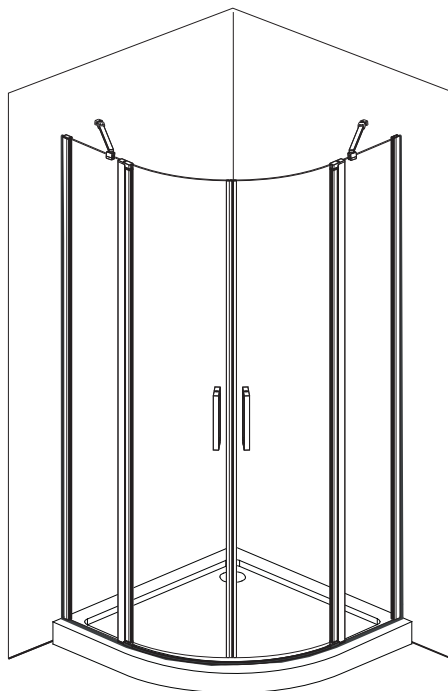

PL INSTRUKCJA MONTAŻU I EKSPLOATACJI

CZ NÁVOD NA MONTÁŽ A ÚDRŽBU

SK NÁVOD NA MONTÁŽ A ÚDRŽBU

EST PAIGALDUS- JA KASUTUSJUHEND

LT MONTAVIMO IR EKSPLOATAVIMO INSTRUKCIJA

LV MONTĀŽAS UN EKSPLUATĀCIJAS INSTRUKCIJA

DE MONTAGE- UND AUFBAUANLEITUNG

RO INSTRUCȚIUNI DE MONTAJ ȘI OPERARE

HU SZERELÉSI ÉS ÜZEMELTETÉSI ÚTMUTATÓ

UA ІНСТРУКЦІЯ З МОНТАЖУ І ЕКСПЛУАТАЦІЇ

BY ІНСТРУКЦЫЯ ПА МАНТАЖЫ І ЭКСПЛУАТАЦЫІ

RU ИНСТРУКЦИЯ ПО МОНТАЖУ И ЭКСПЛУАТАЦИИ

EN INSTRUCTIONS FOR ASSEMBLY AND USE

FR INSTALLATION ET UTILISATION - MODE

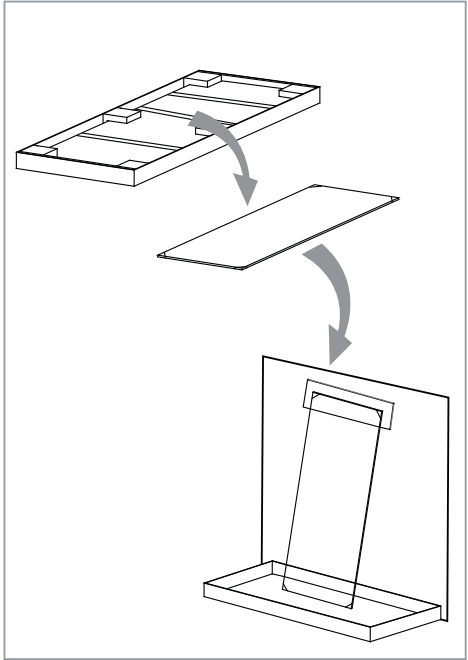
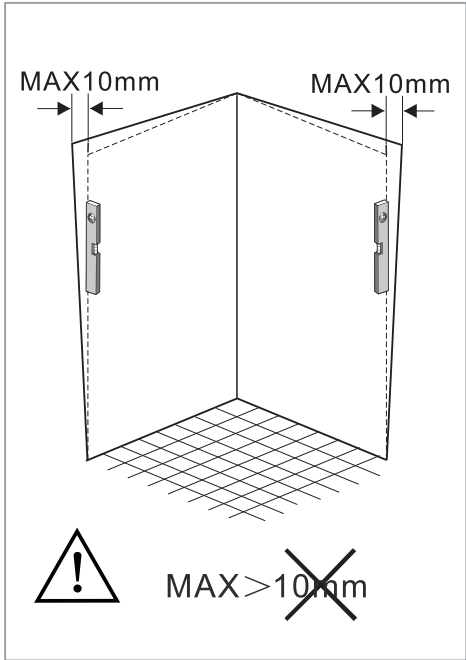
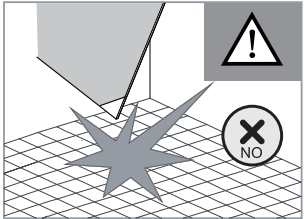
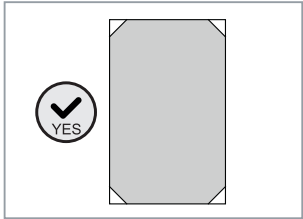
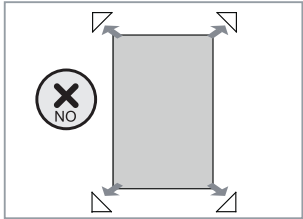
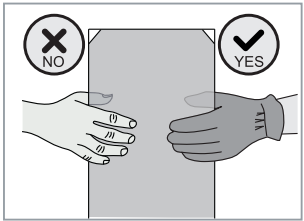
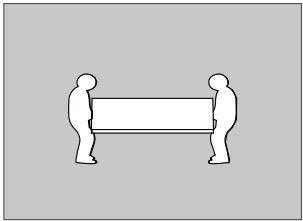
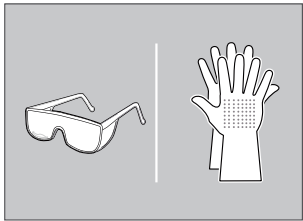
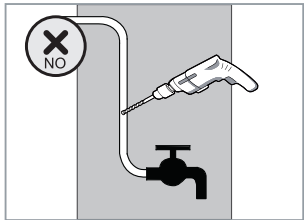
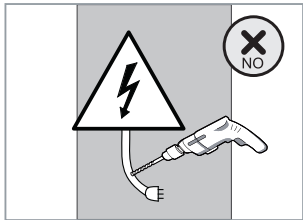
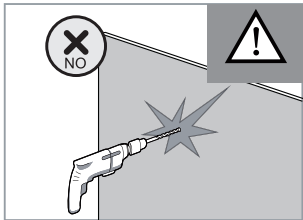

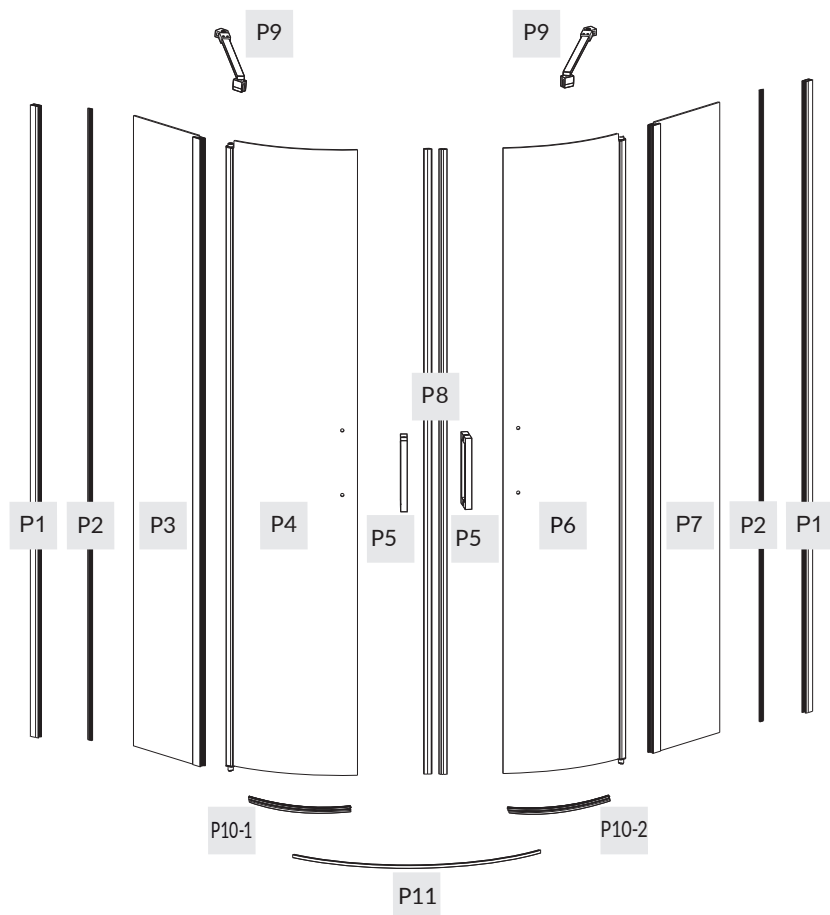

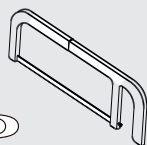
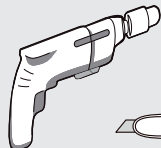
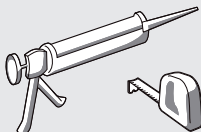
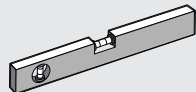
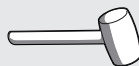
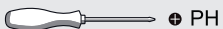
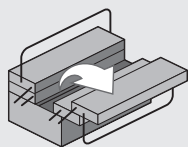
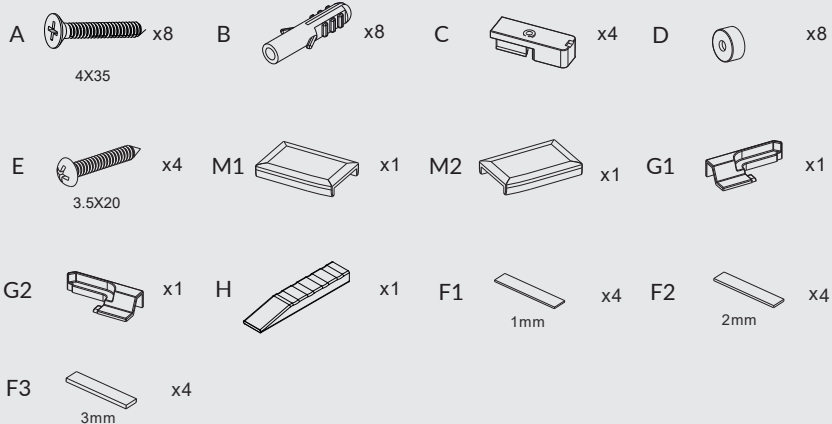
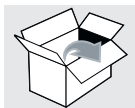

1.

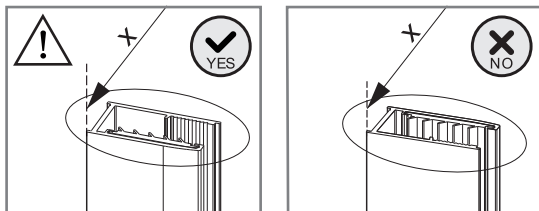

SIZE (mm)	X (mm)
800x800	783
900x900	883

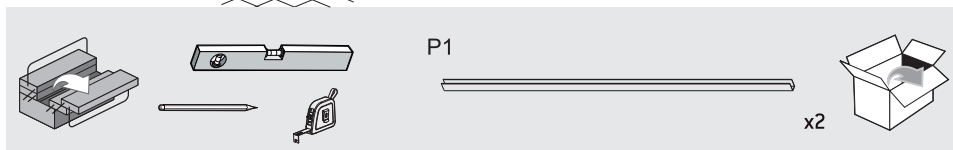
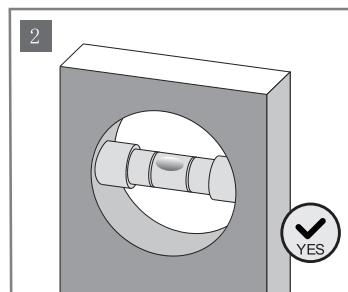
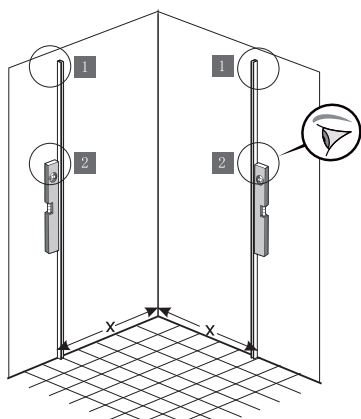
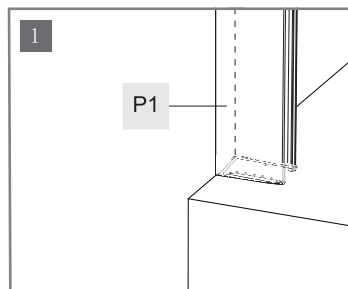
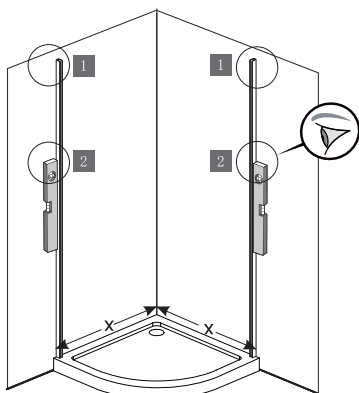

2.

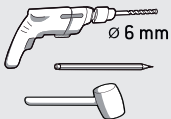
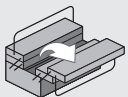
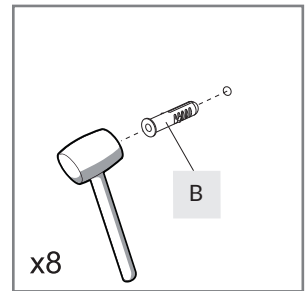
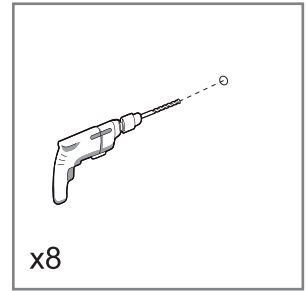
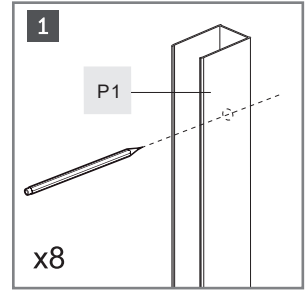
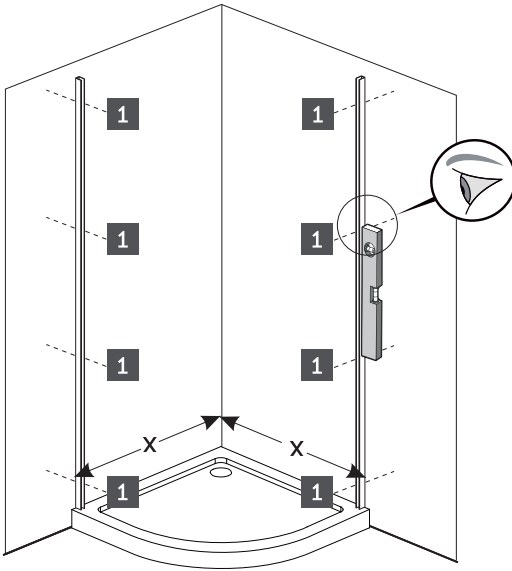
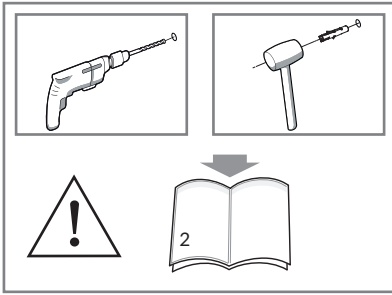

P1



x2

B



x8



3.

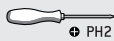
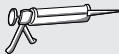
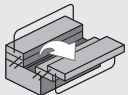
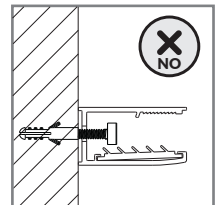
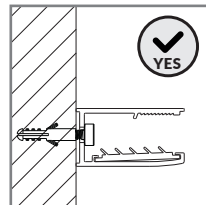
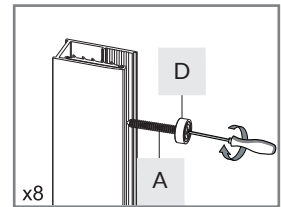
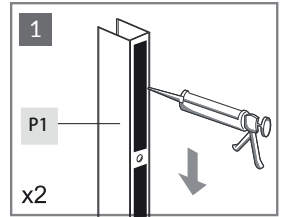
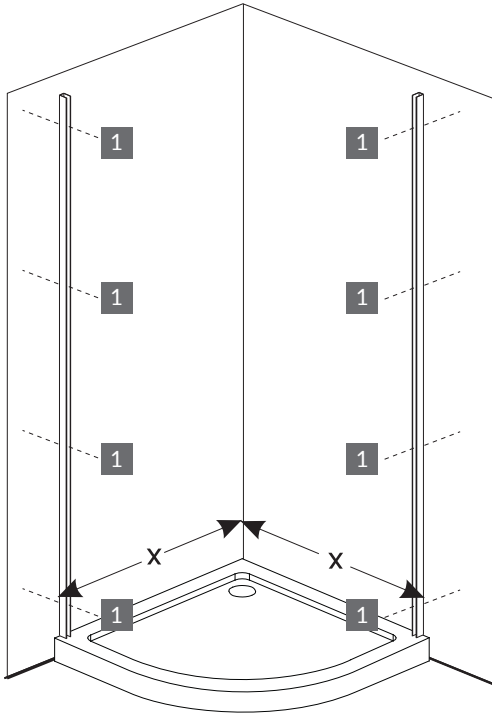

P1



x2

D



x8

A



x8



4.

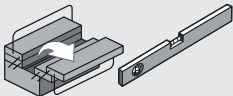
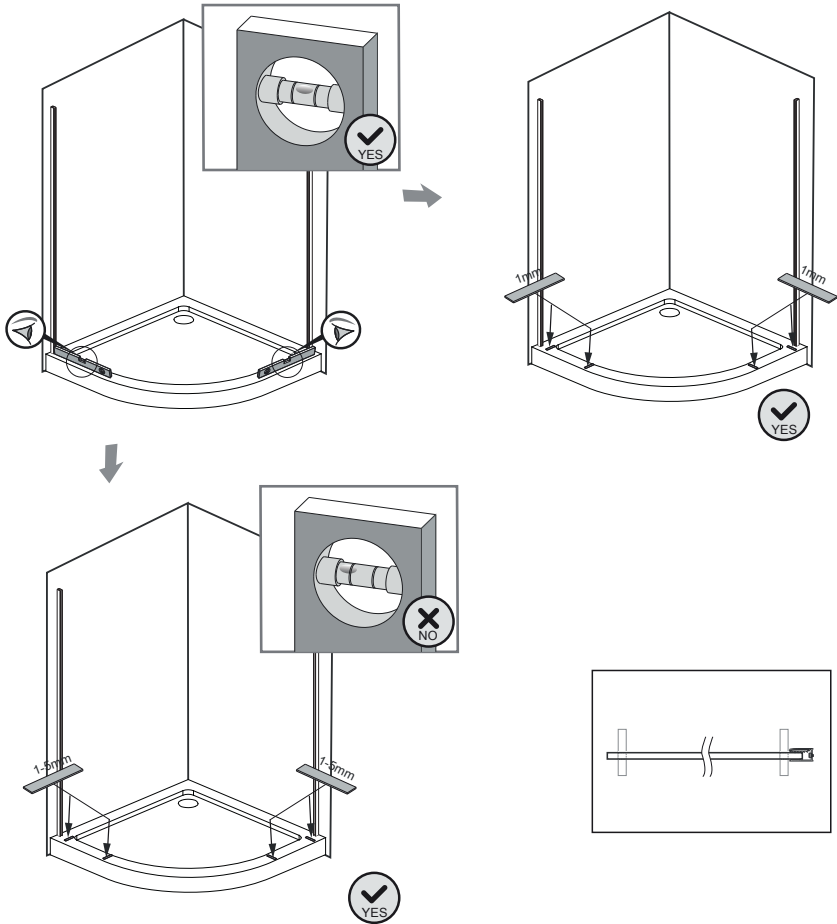

F1



x4

F2



x4

F3







x4

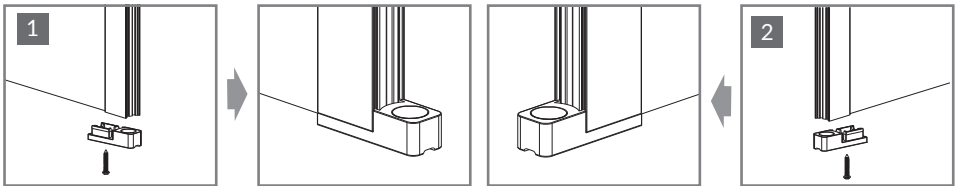
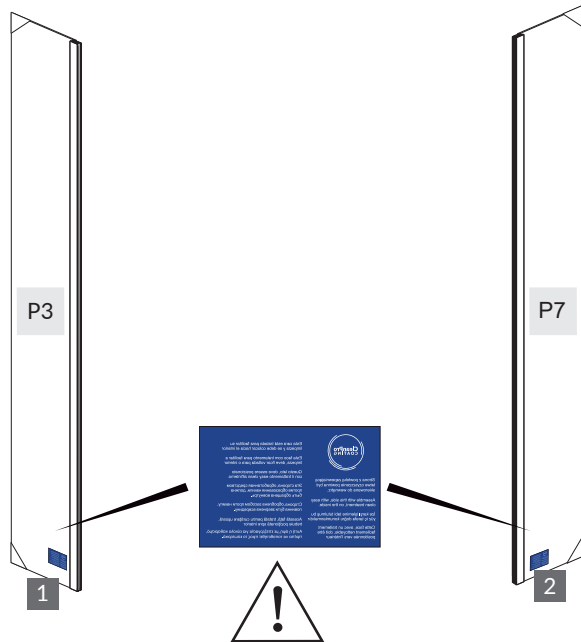

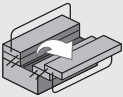
5.

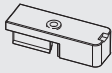
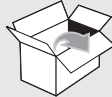

		C		x2	
		E		x2	

6.

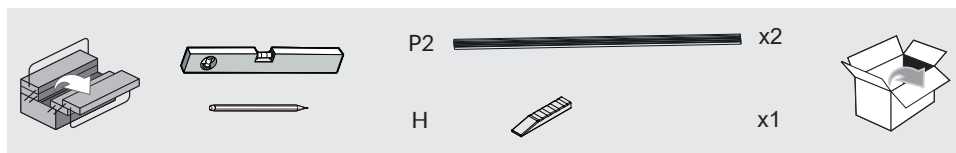
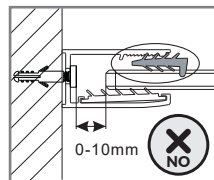
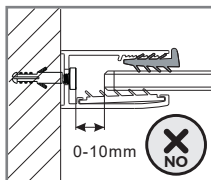
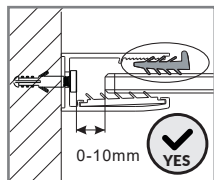
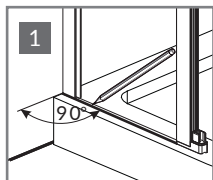
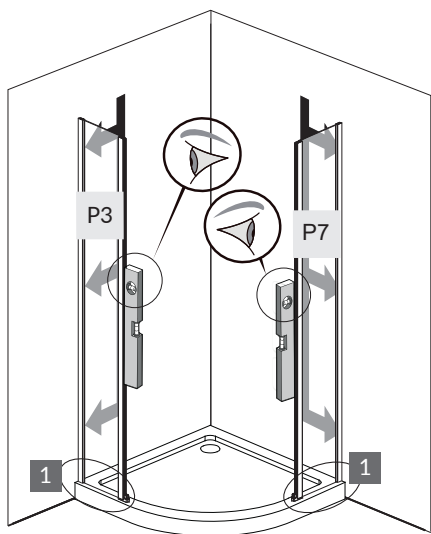
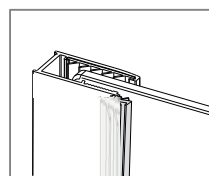
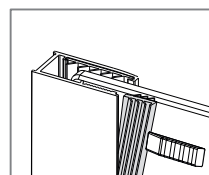
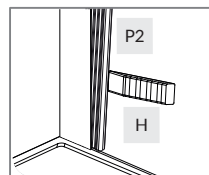
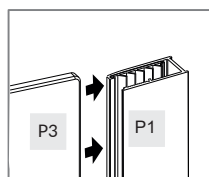
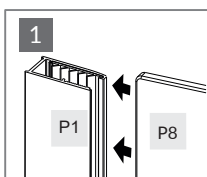
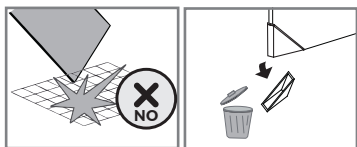

7.

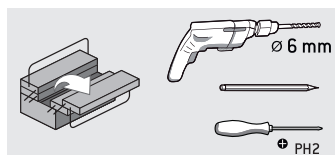
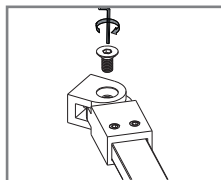
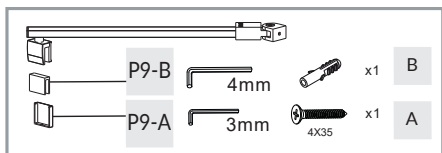
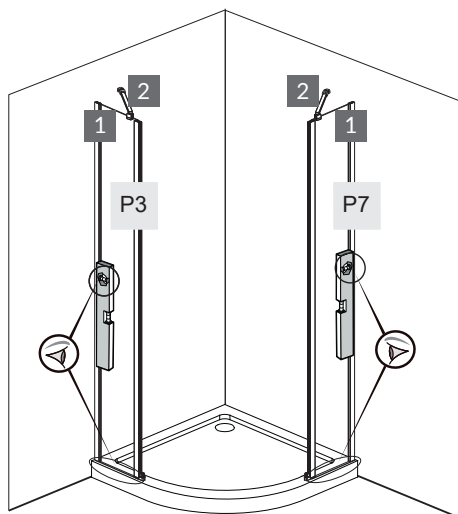
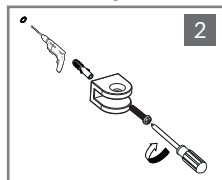
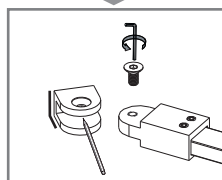
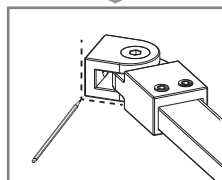
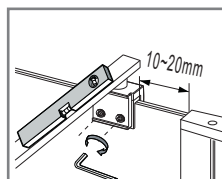
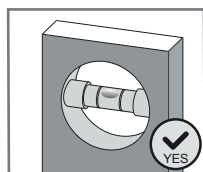
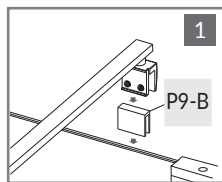
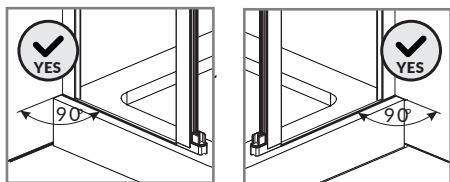

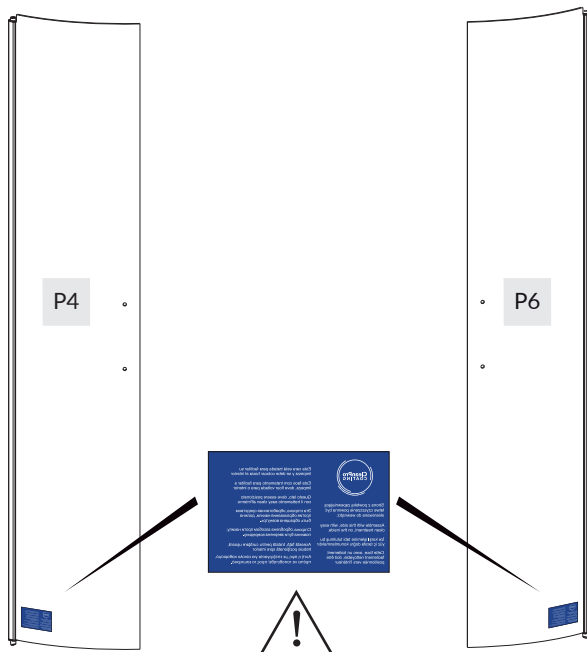

9.

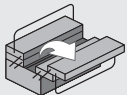
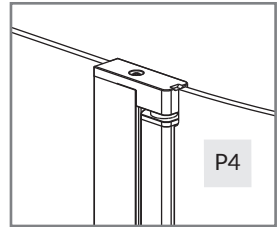
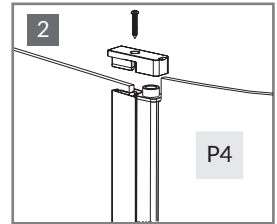
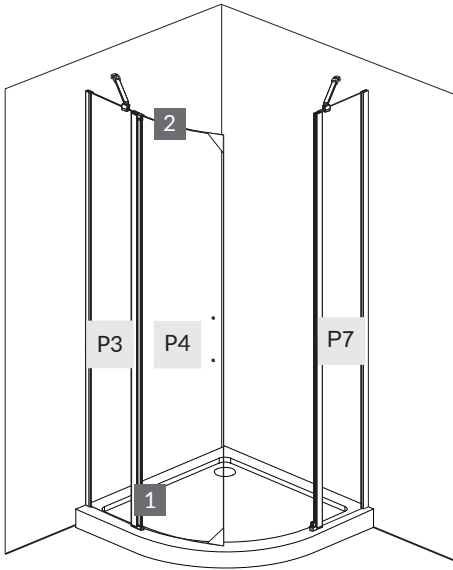
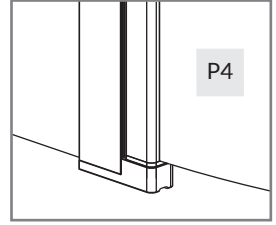
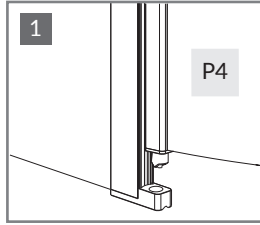
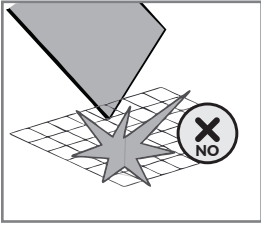

C

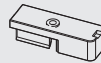

x1

E



x1



10.

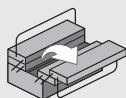
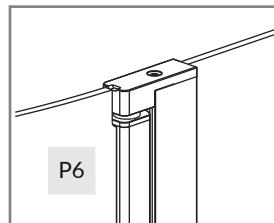
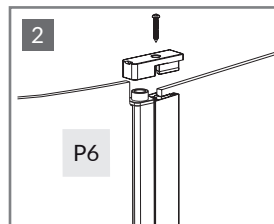
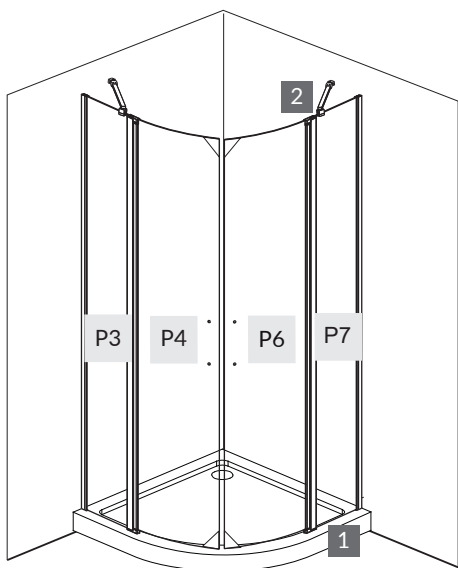
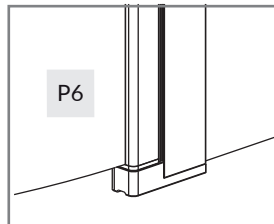
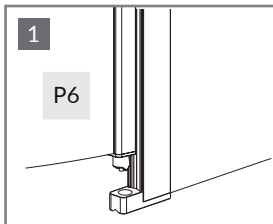
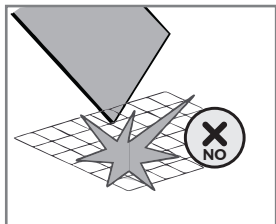

C

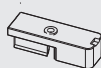

x1

E





x1

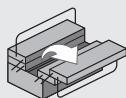
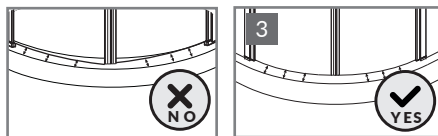
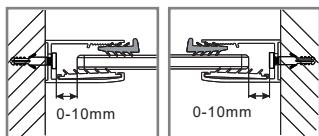
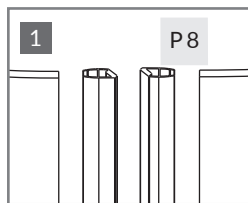
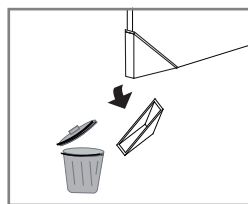
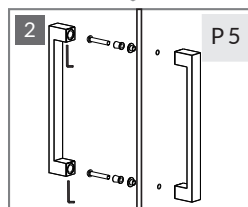
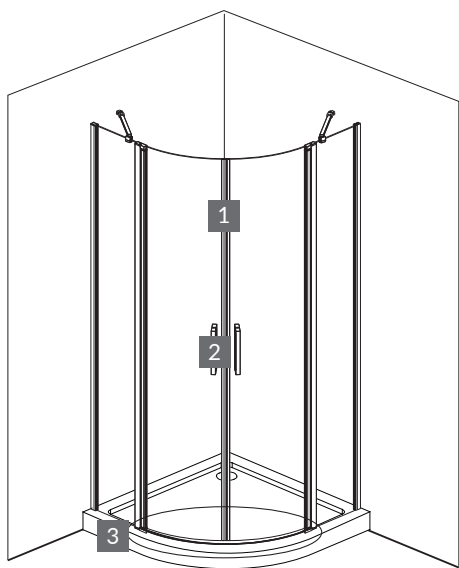
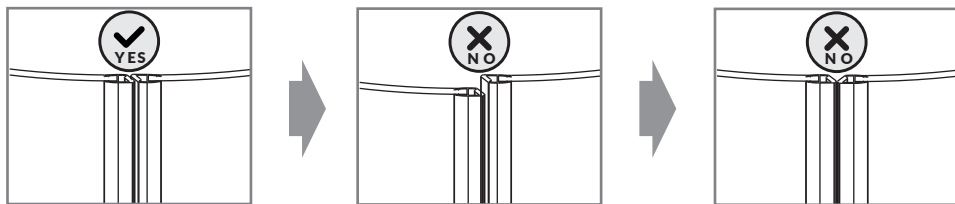

11.



P8  x2

P5  x2 



12.

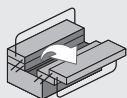
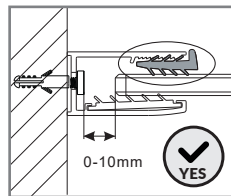
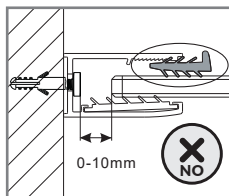
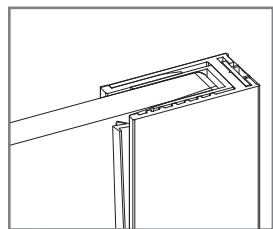
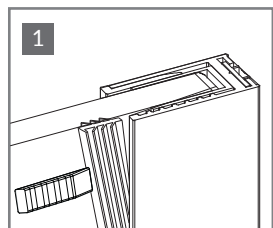
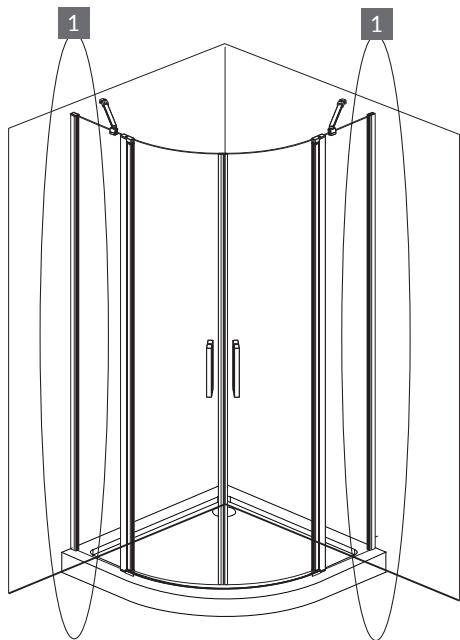
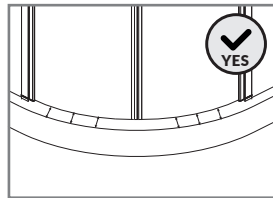
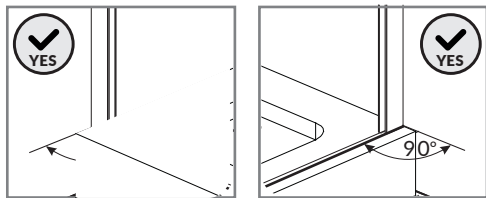

H



x1



13.

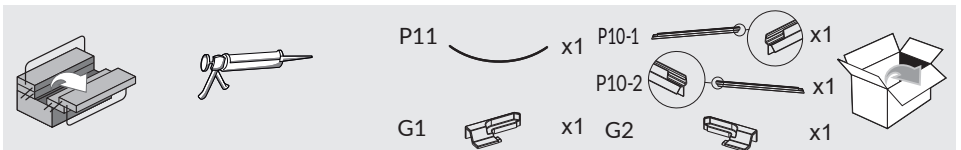
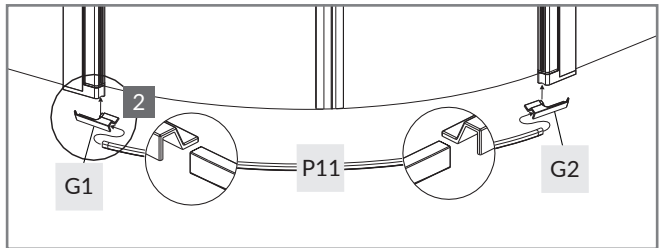
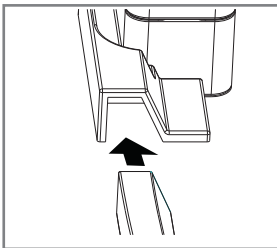
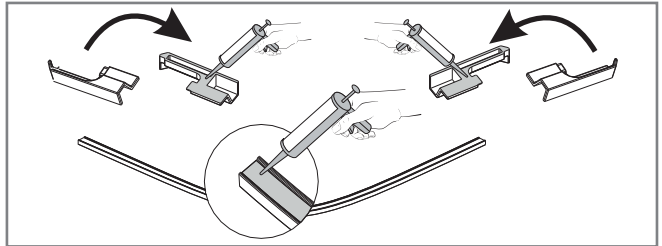
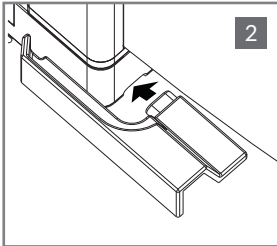
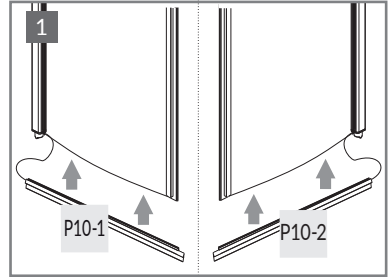
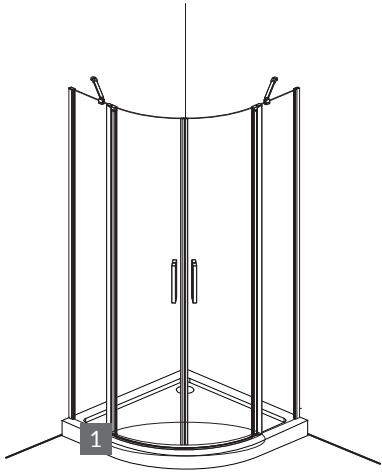

14.

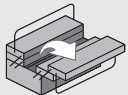
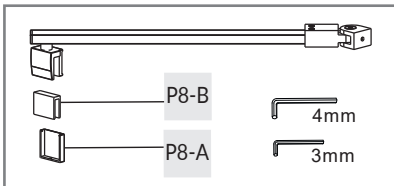
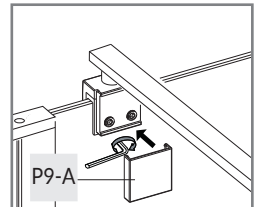
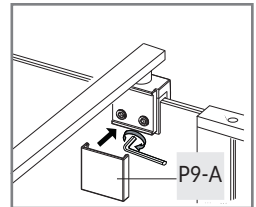
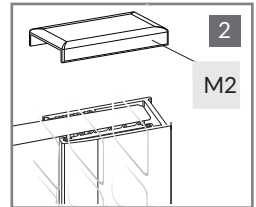
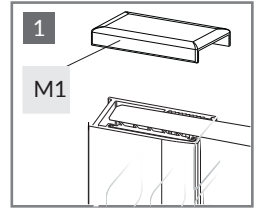
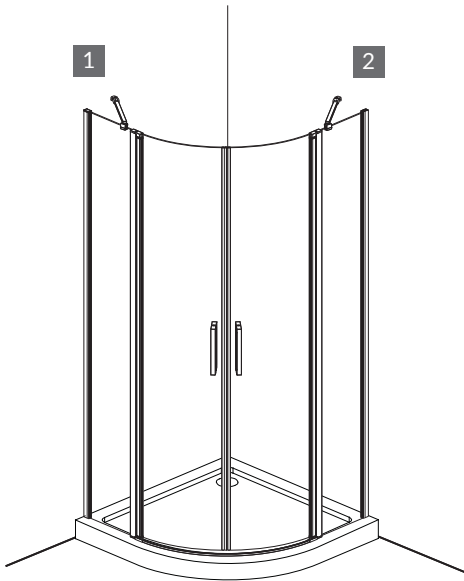
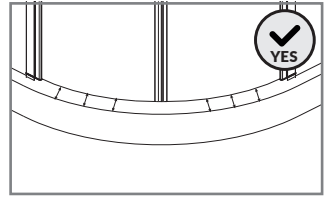
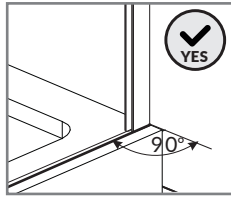
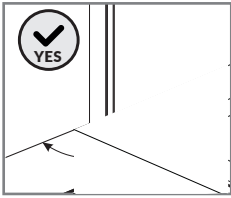

P9  x2

M1  x1

M2  x1



15.

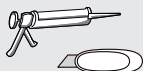
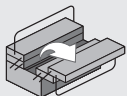
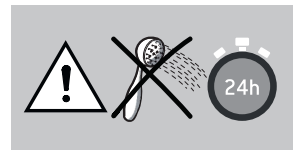
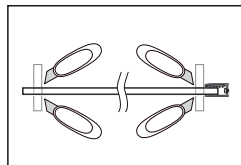
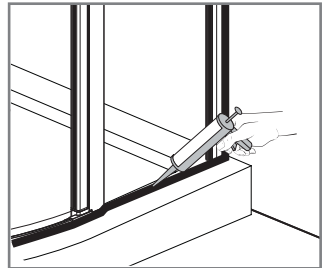
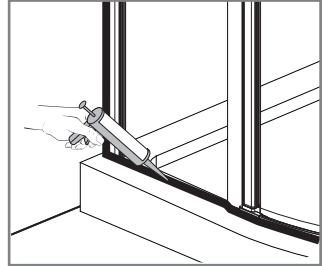
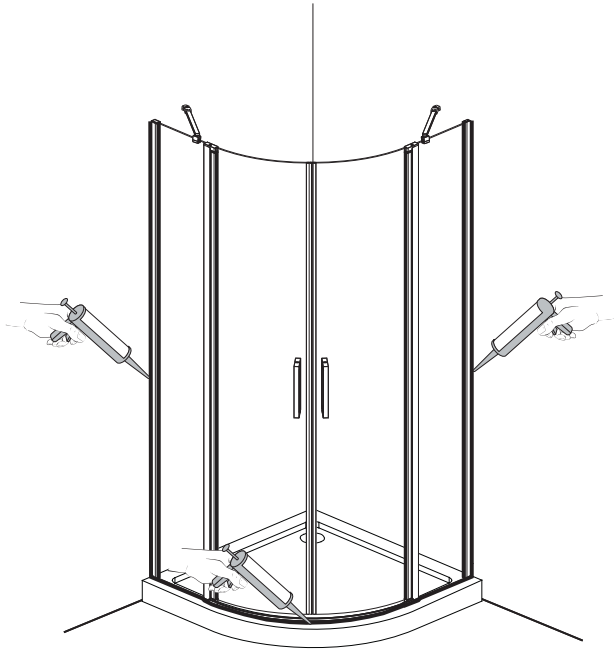



6.5<PH<7.5

